

COMPOSITION COMPLEXES DE FACADES 1

1.10 / ECOLE / MOB / Ossature principale 145

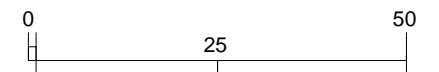
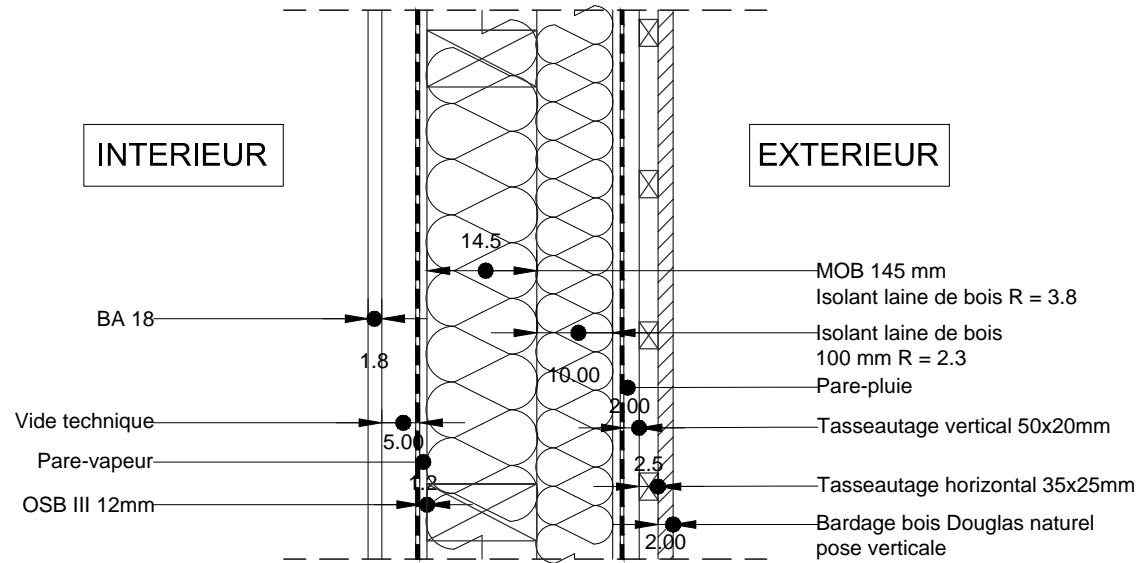

COMPOSITION COMPLEXES DE FACADES 2

1.10 / **ECOLE** / MOB / Ossature principale 145 / 2 BA13

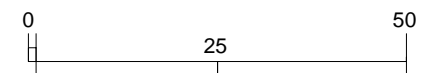
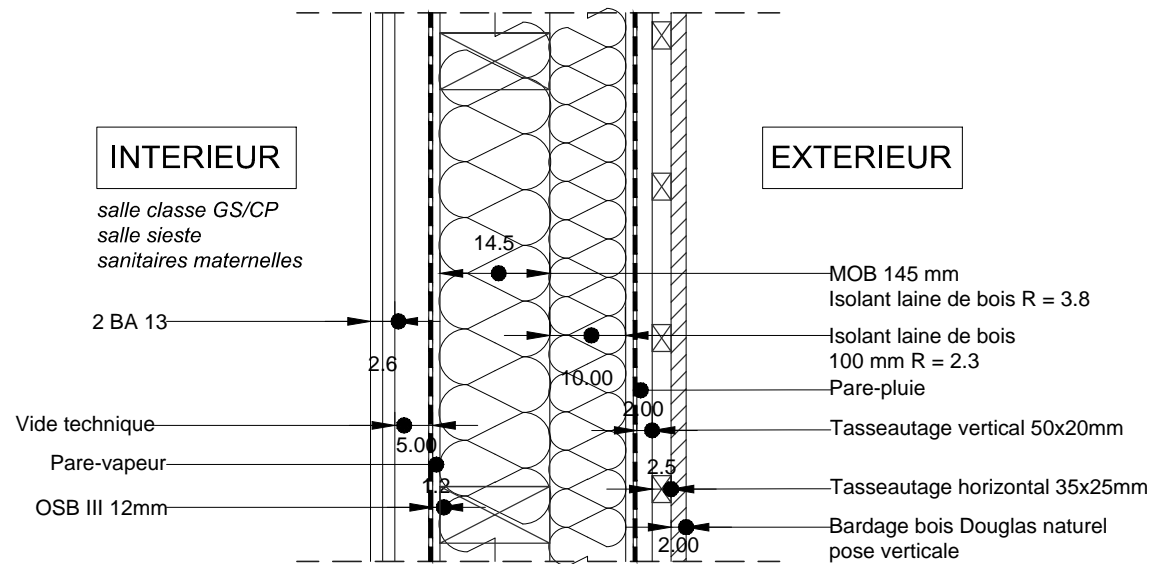
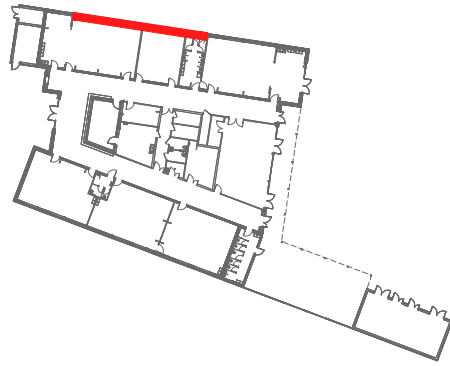

COMPOSITION COMPLEXES DE FACADES 4

1.10 / ECOLE / Maçonnerie 200 + bardage bois

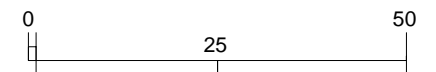
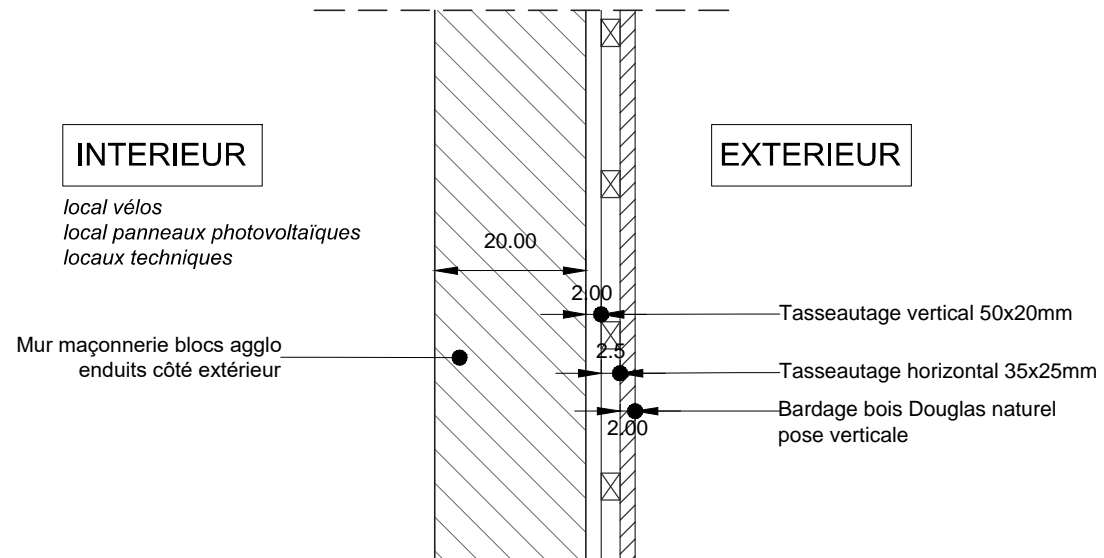
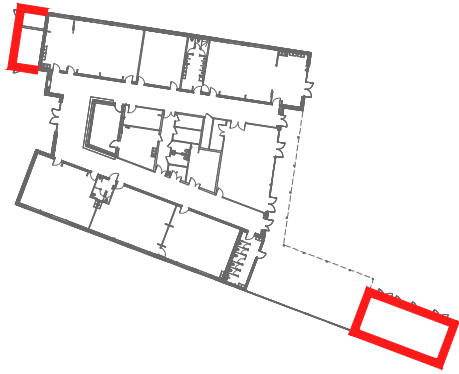

COMPOSITION COMPLEXES DE FACADES 6

1.10 / ECOLE / Poteau + bardage bois

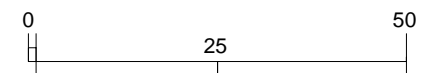
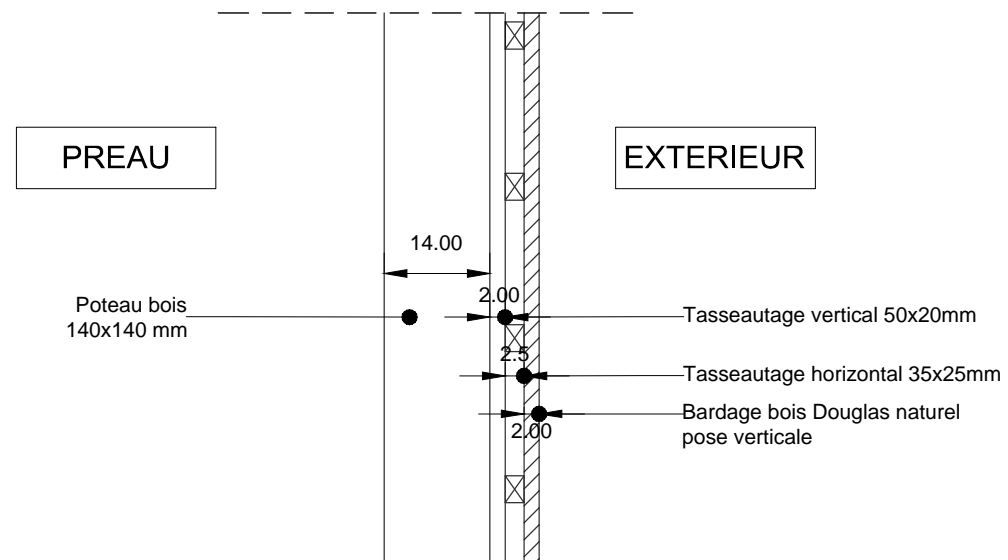
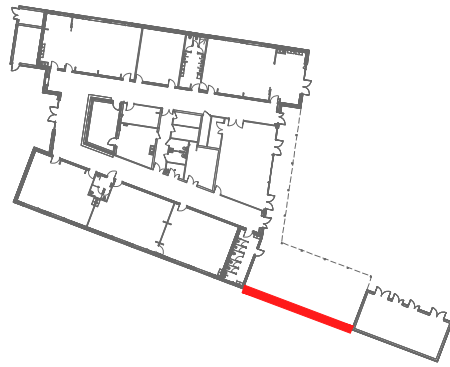

COMPOSITION COMPLEXES DE FACADES S1

1.10 / SALLE MULTIACTIVITES / Socle maçonné

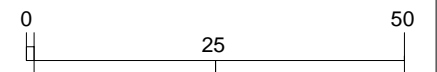
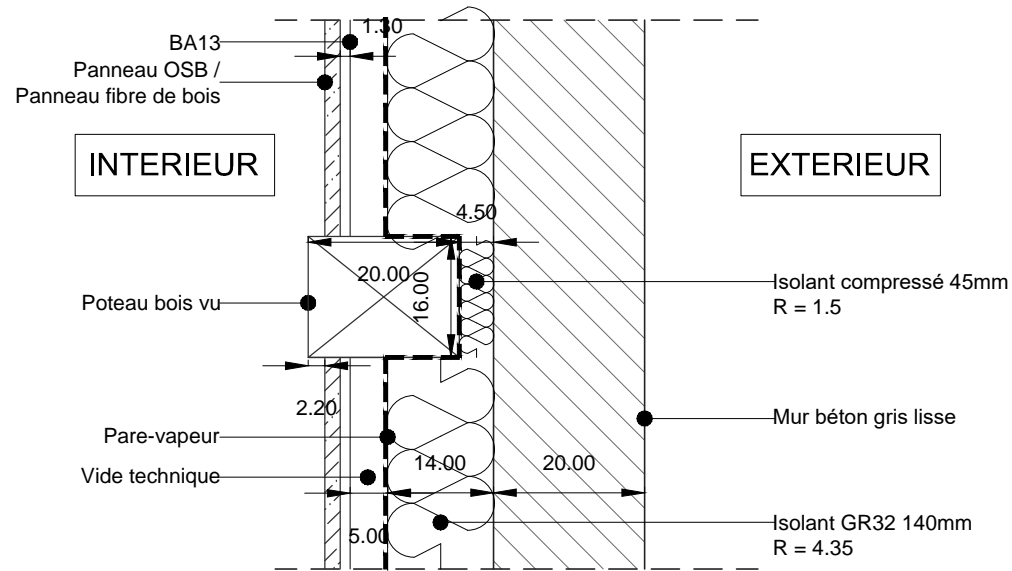
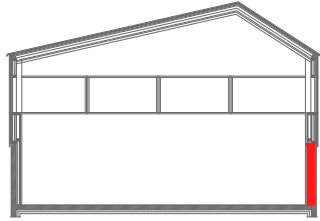

COMPOSITION COMPLEXES DE FACADES S2

1.10 / SALLE MULTIACTIVITES / MOB

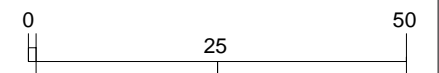
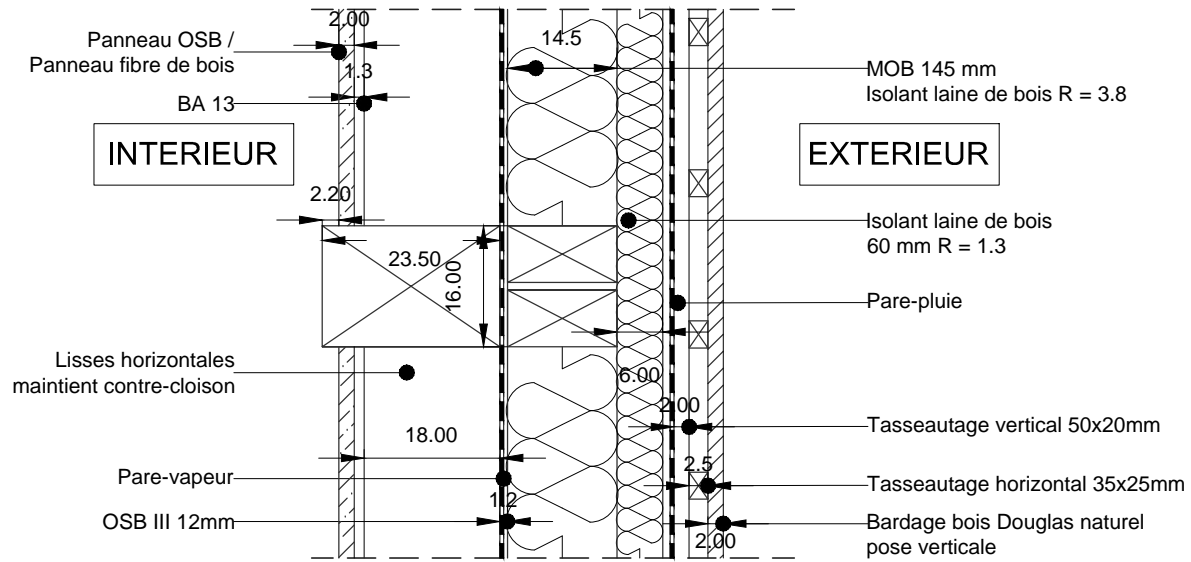
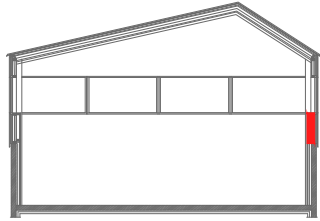

COMPOSITION COMPLEXES DE FACADES S3

1.10 / SALLE MULTIACTIVITES / MOB

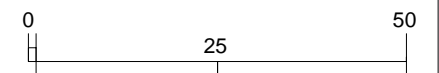
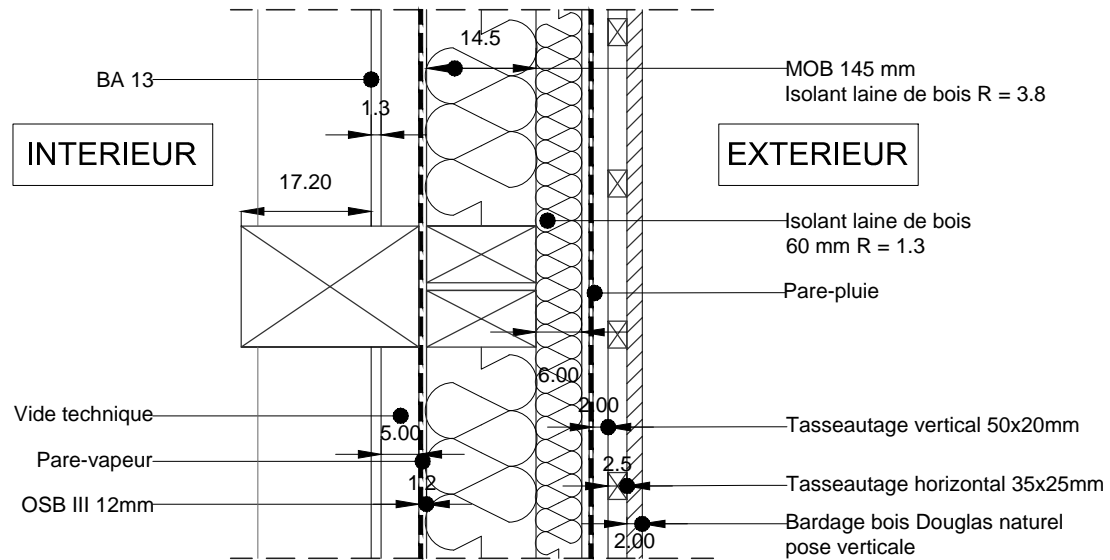
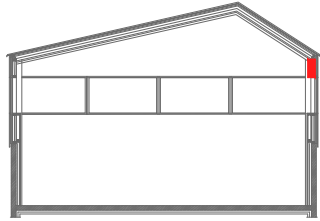

1.10 / ECOLE / Coupe sur pied de façade MOB + bardage bois

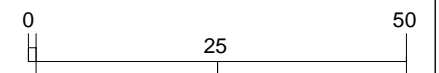
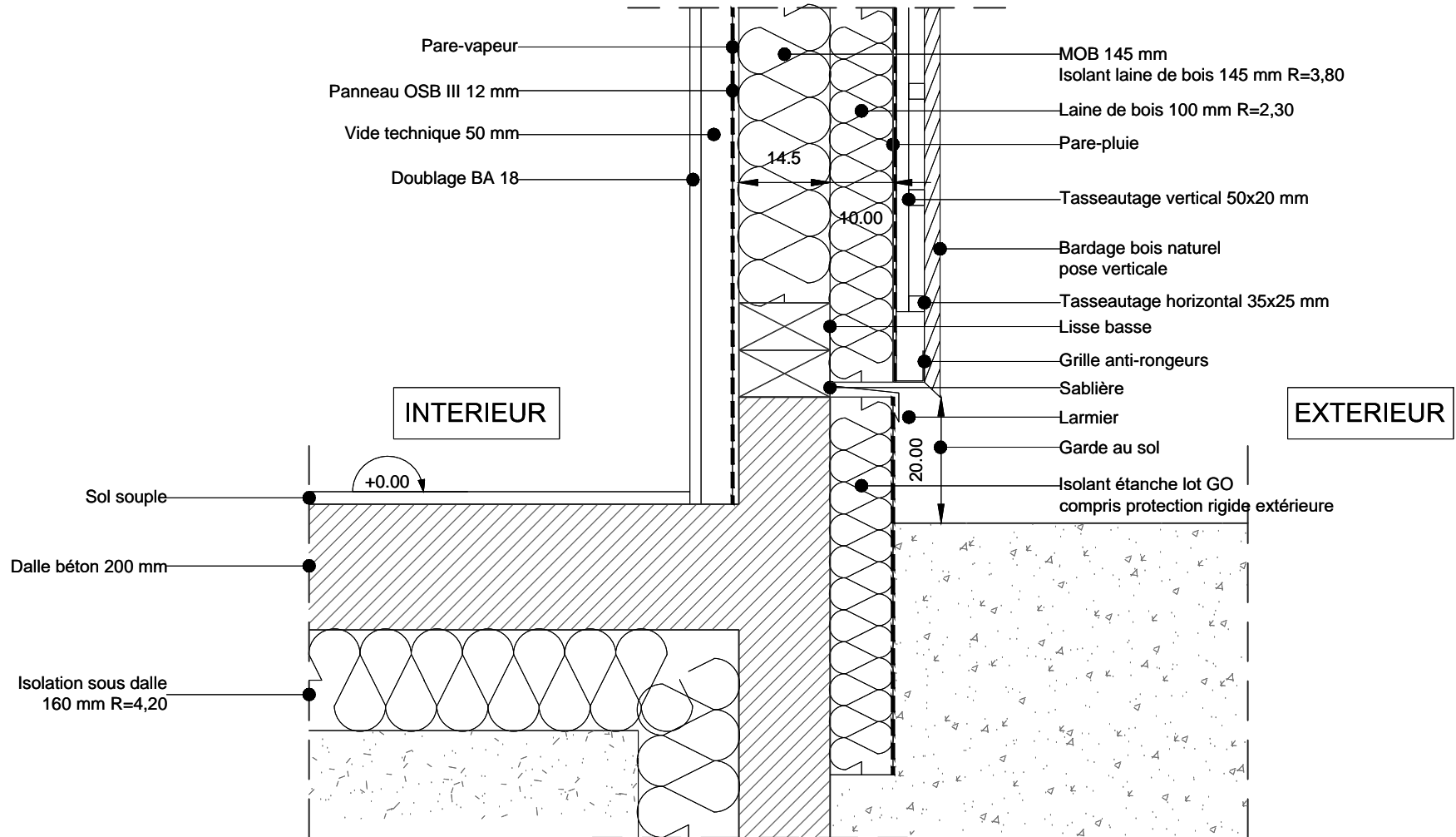

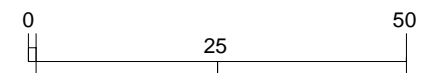
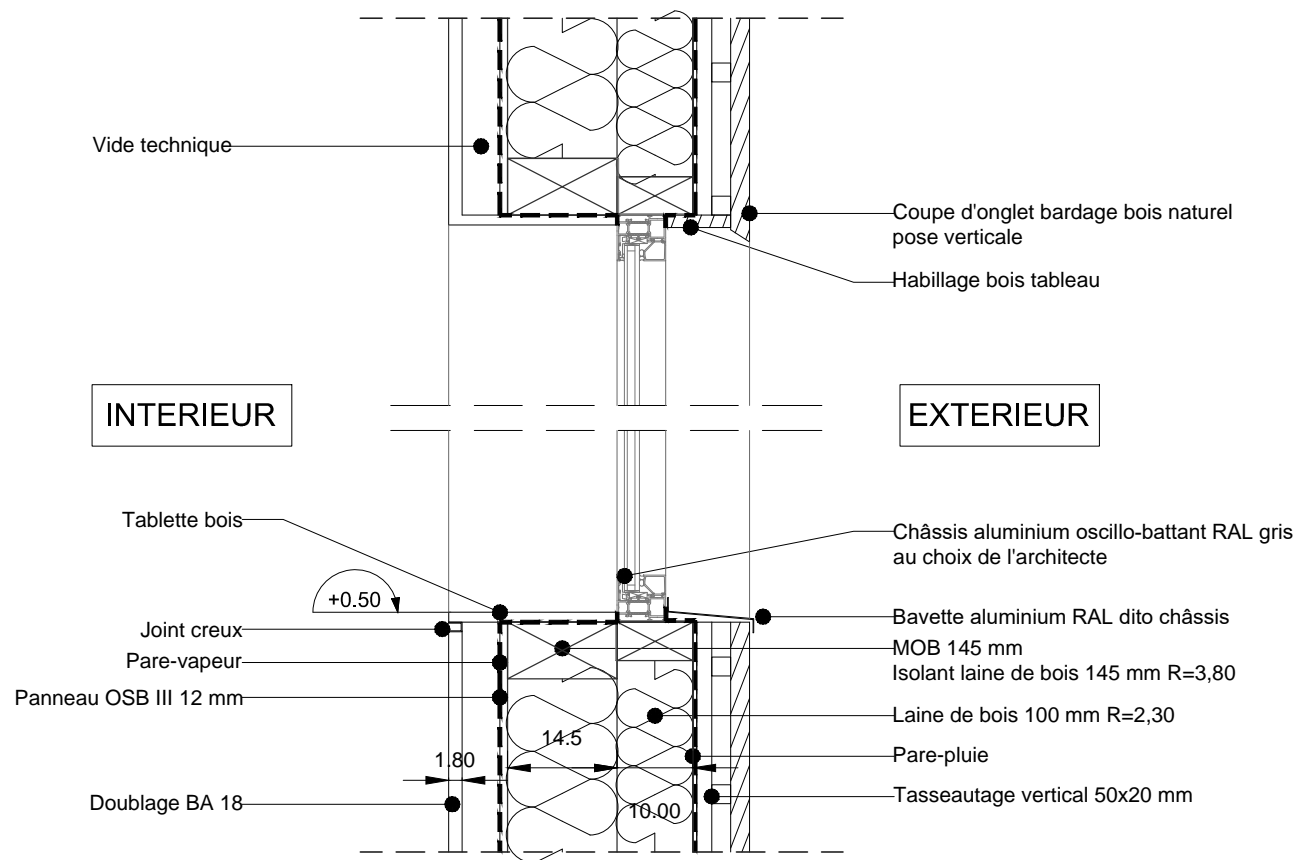

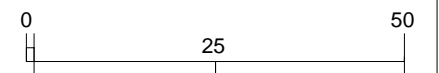
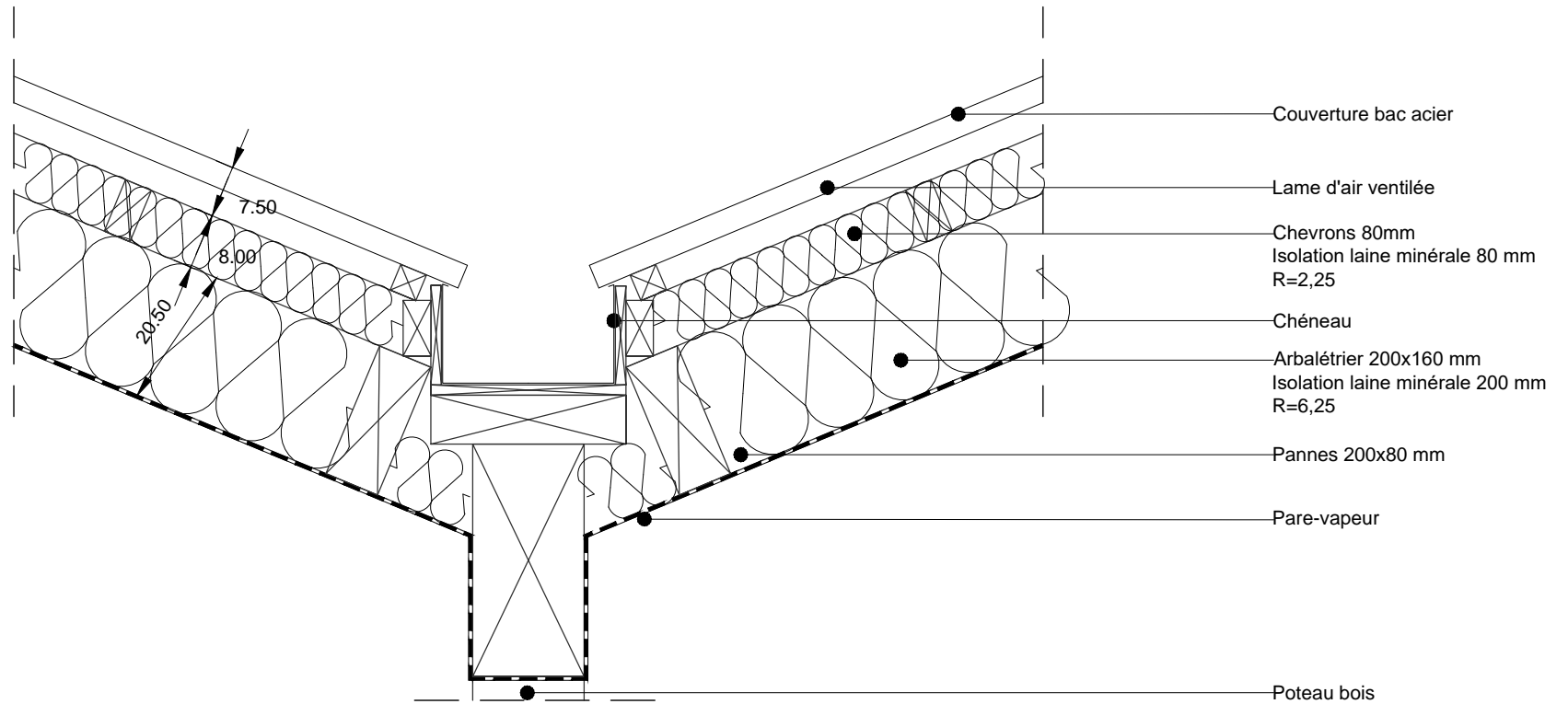

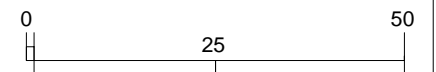
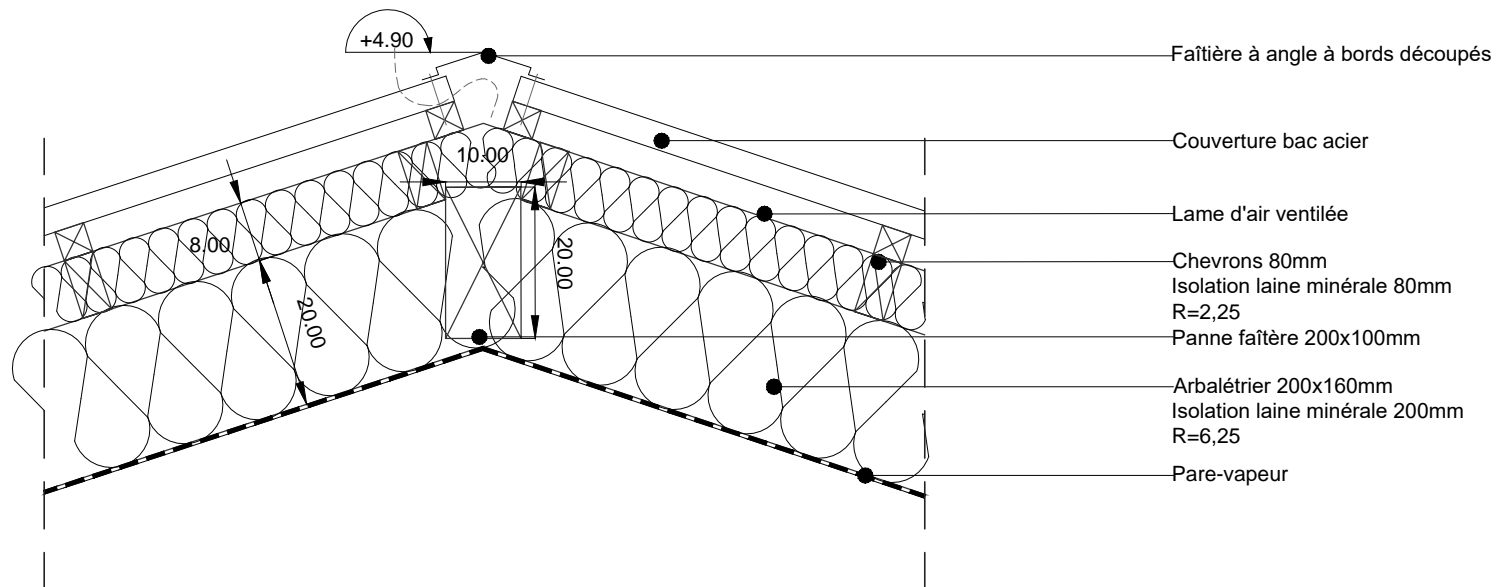

1.10 / ECOLE / Faîtage toiture longère Sud : couverture bac acier + chaume

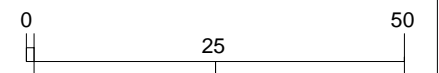
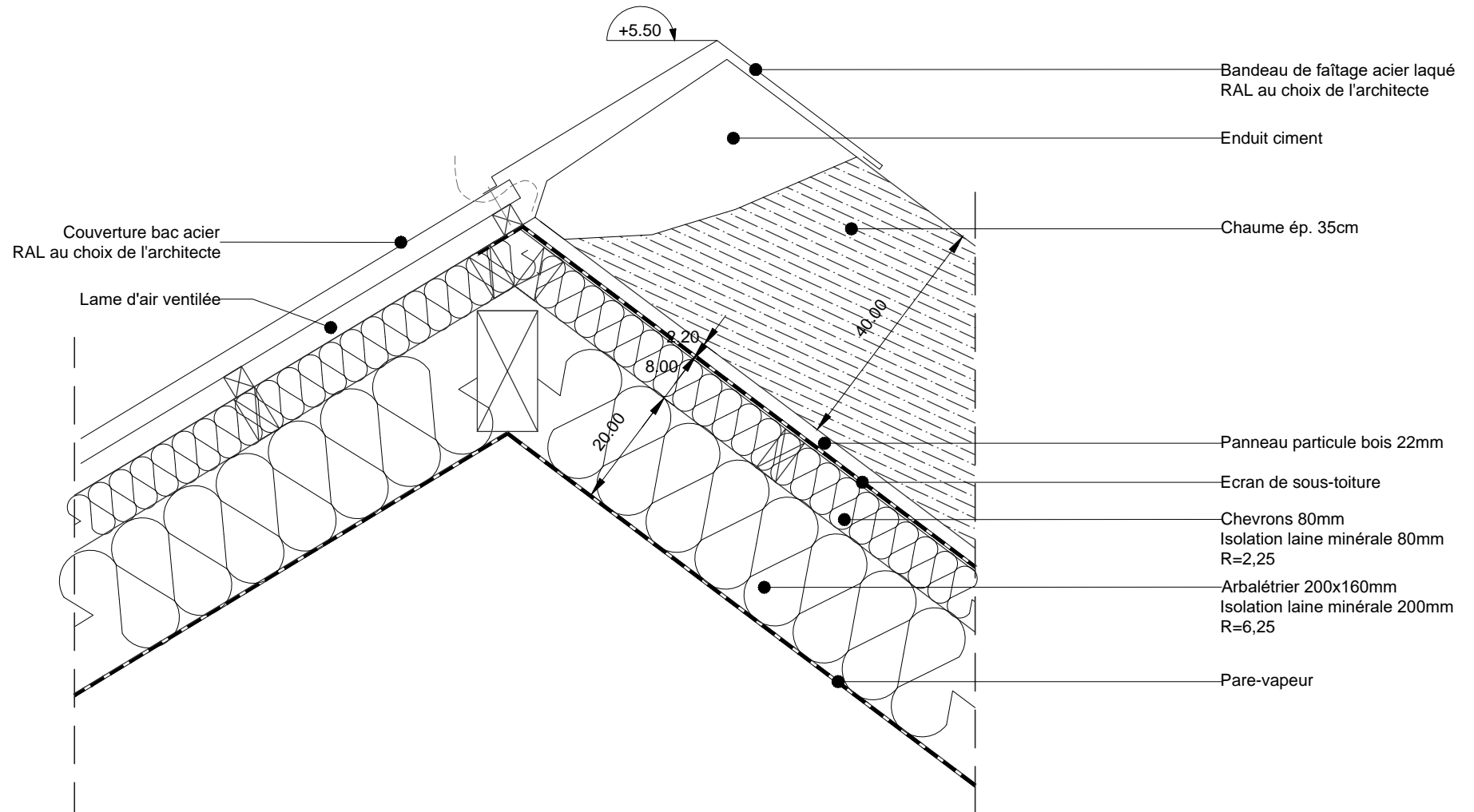

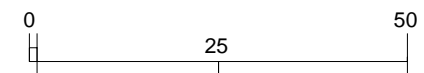
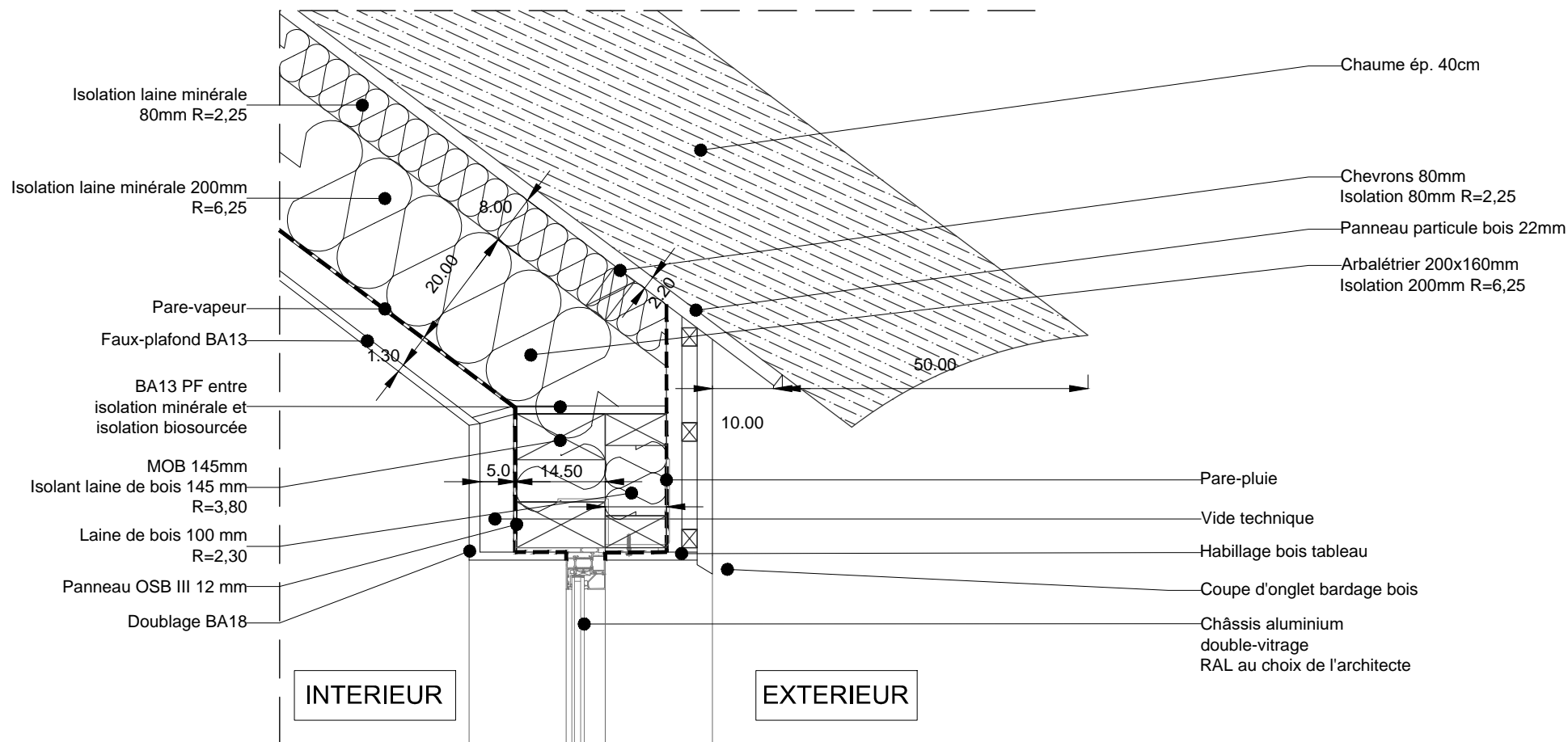

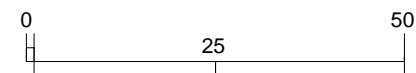
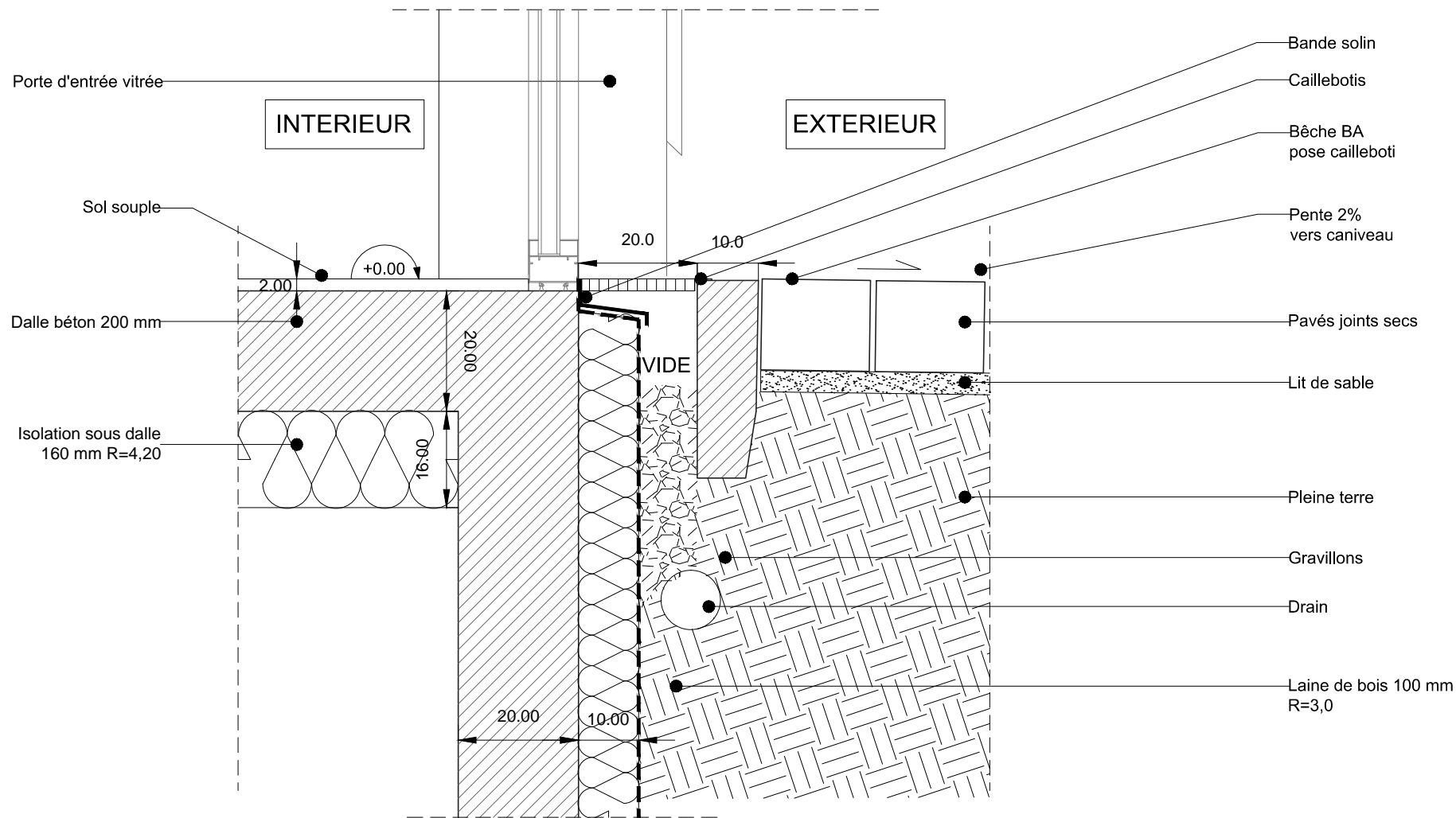

1.10 / ECOLE / SEUIL ENSEMBLE MENUISE COTE COUR

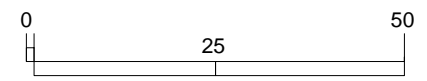
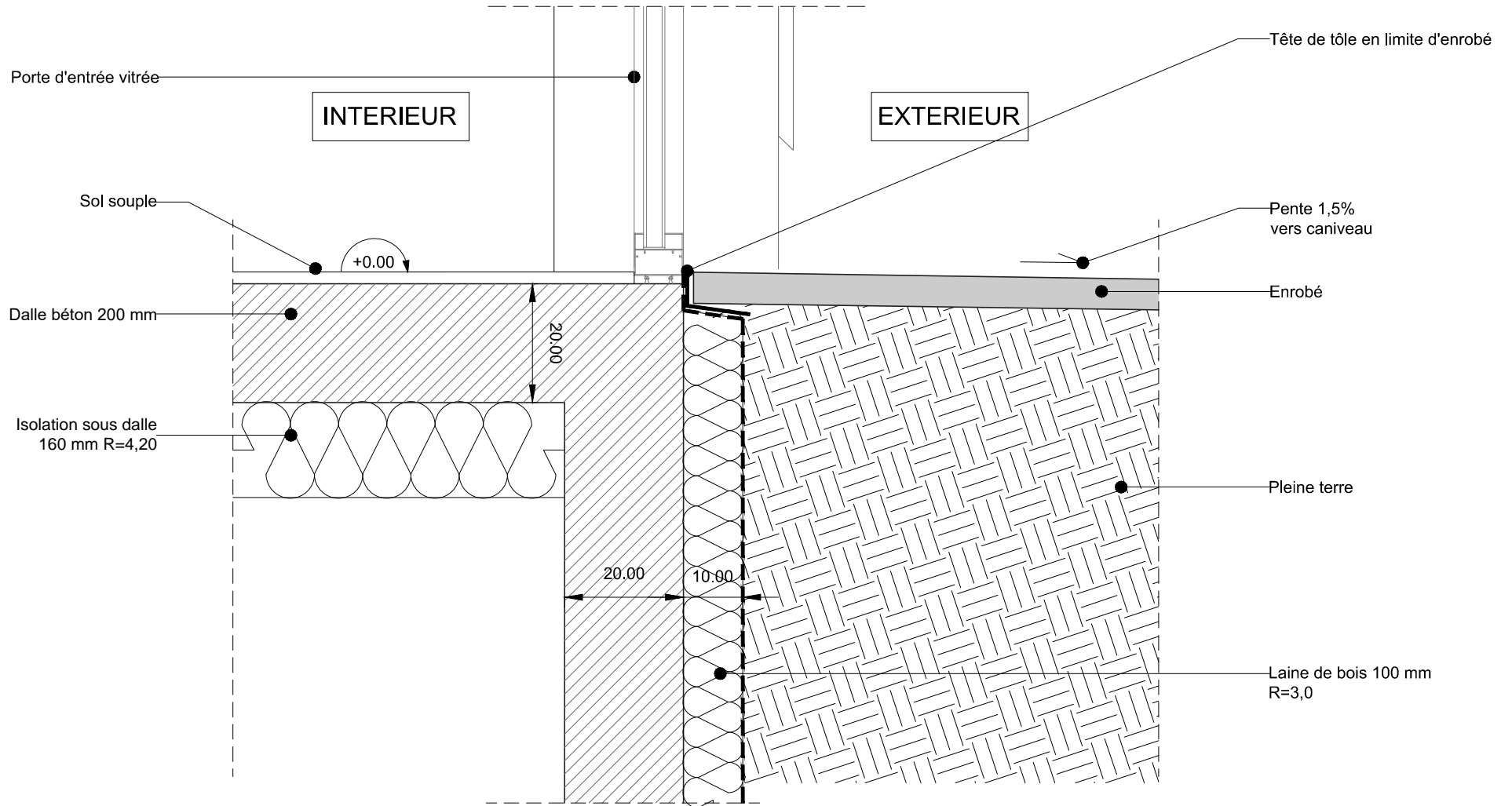

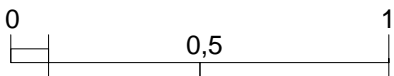
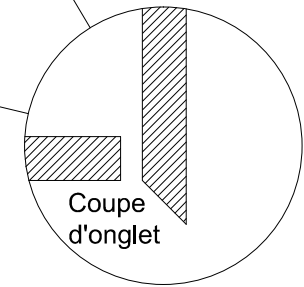
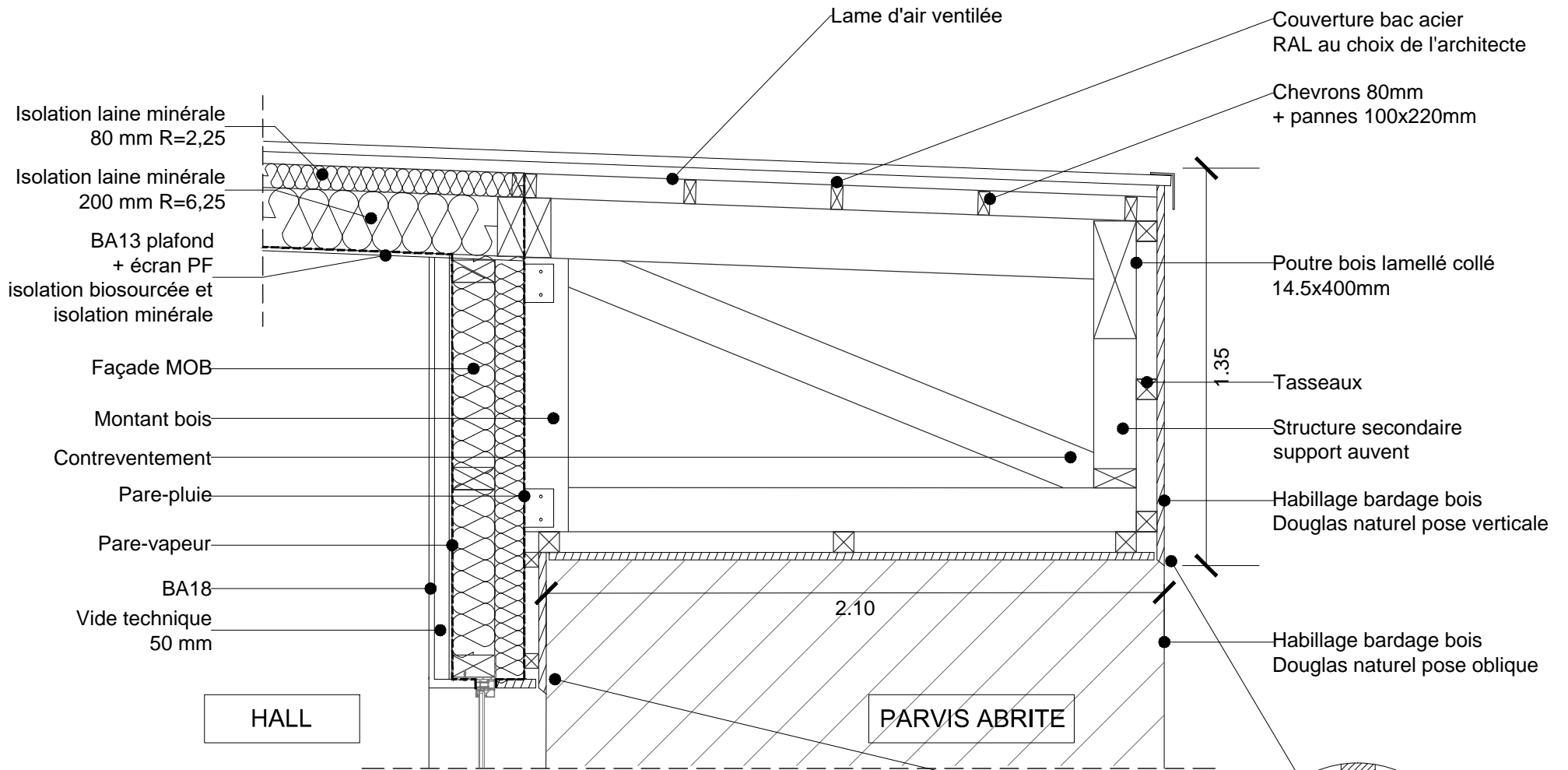

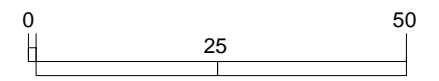
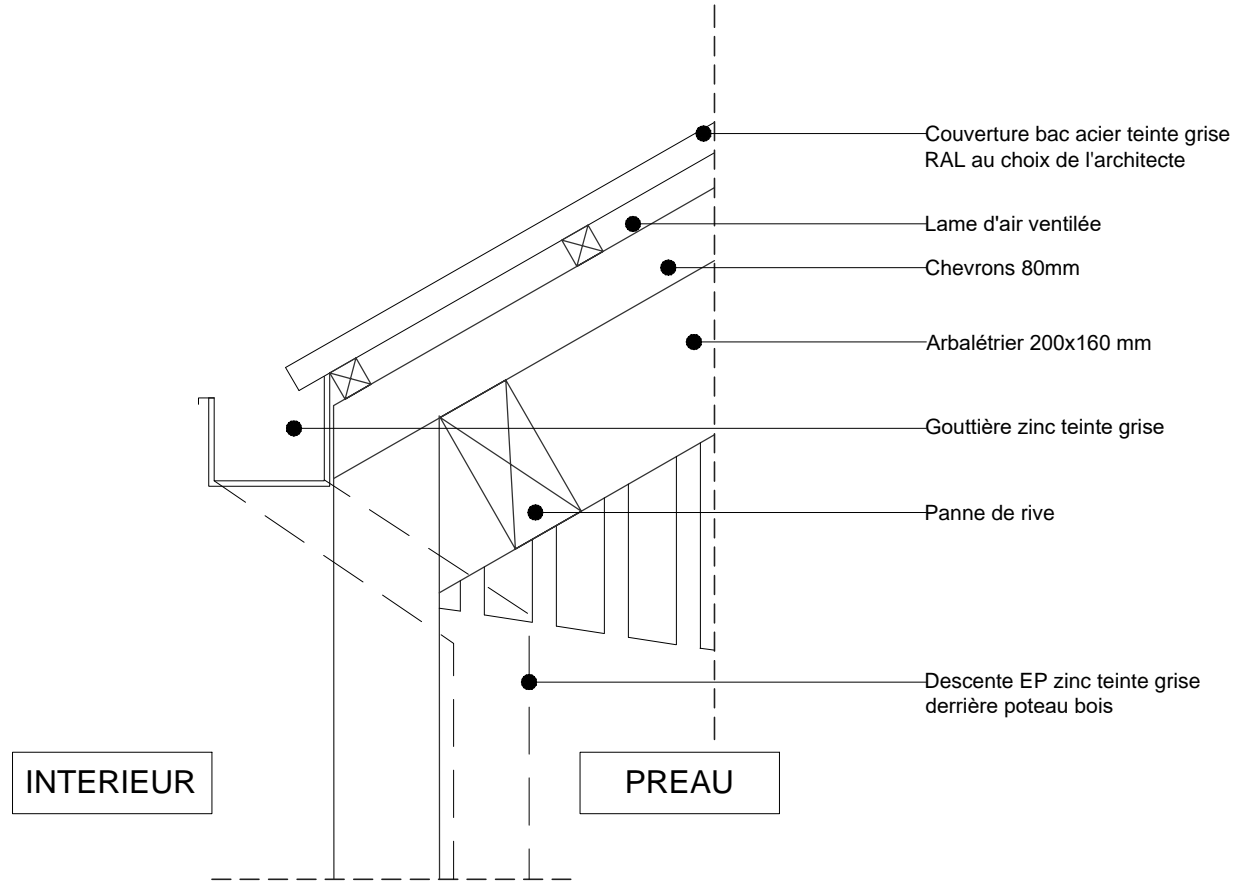
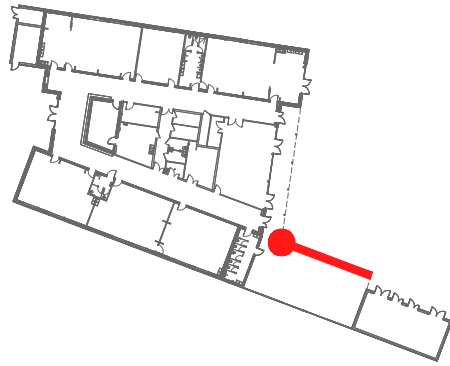

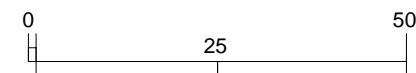
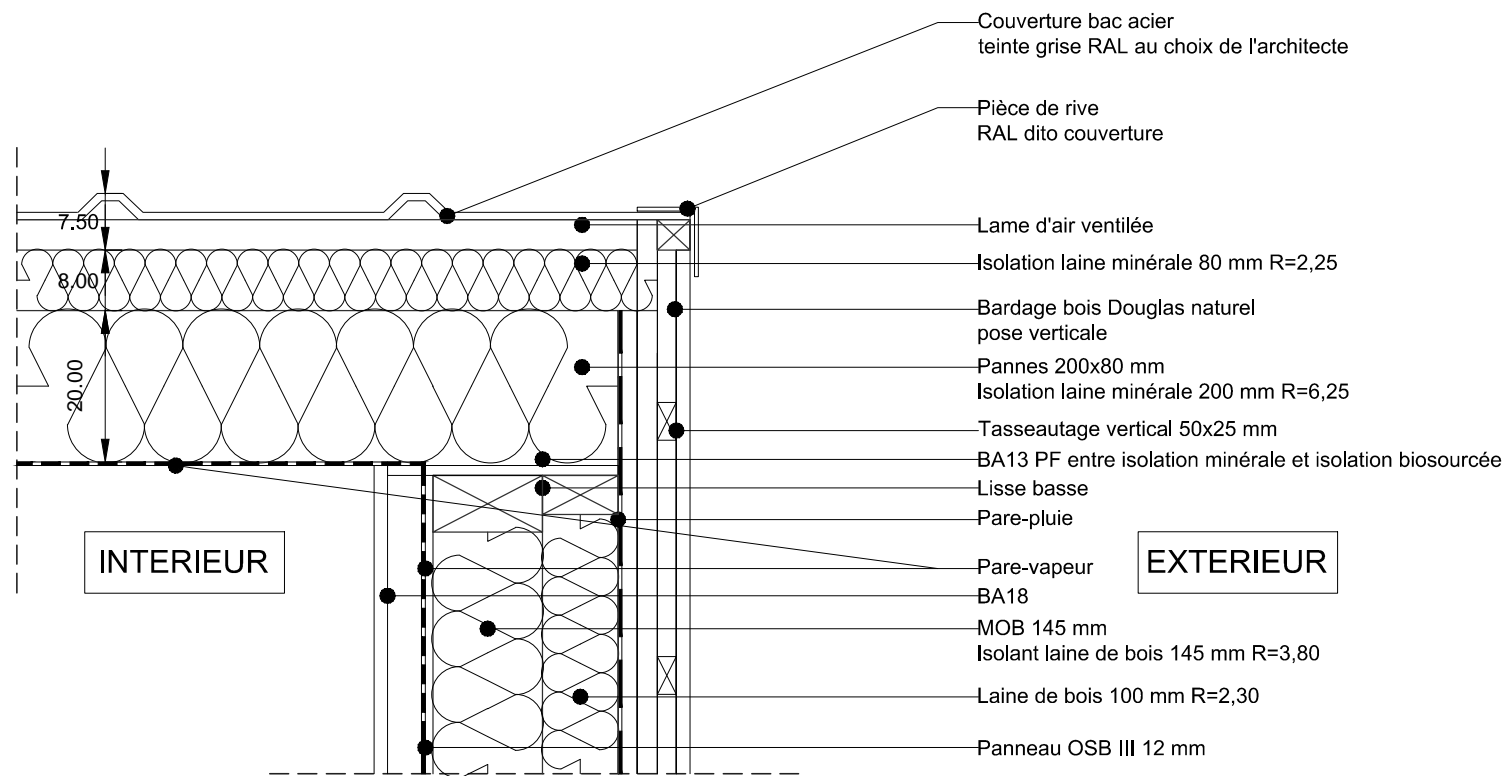
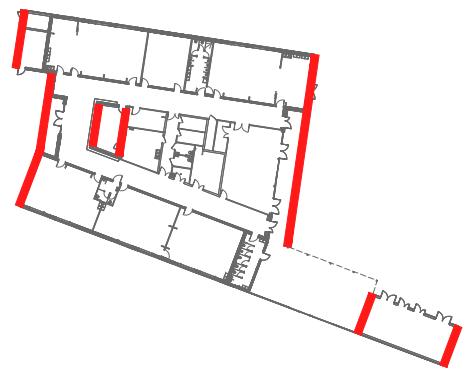

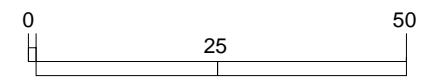
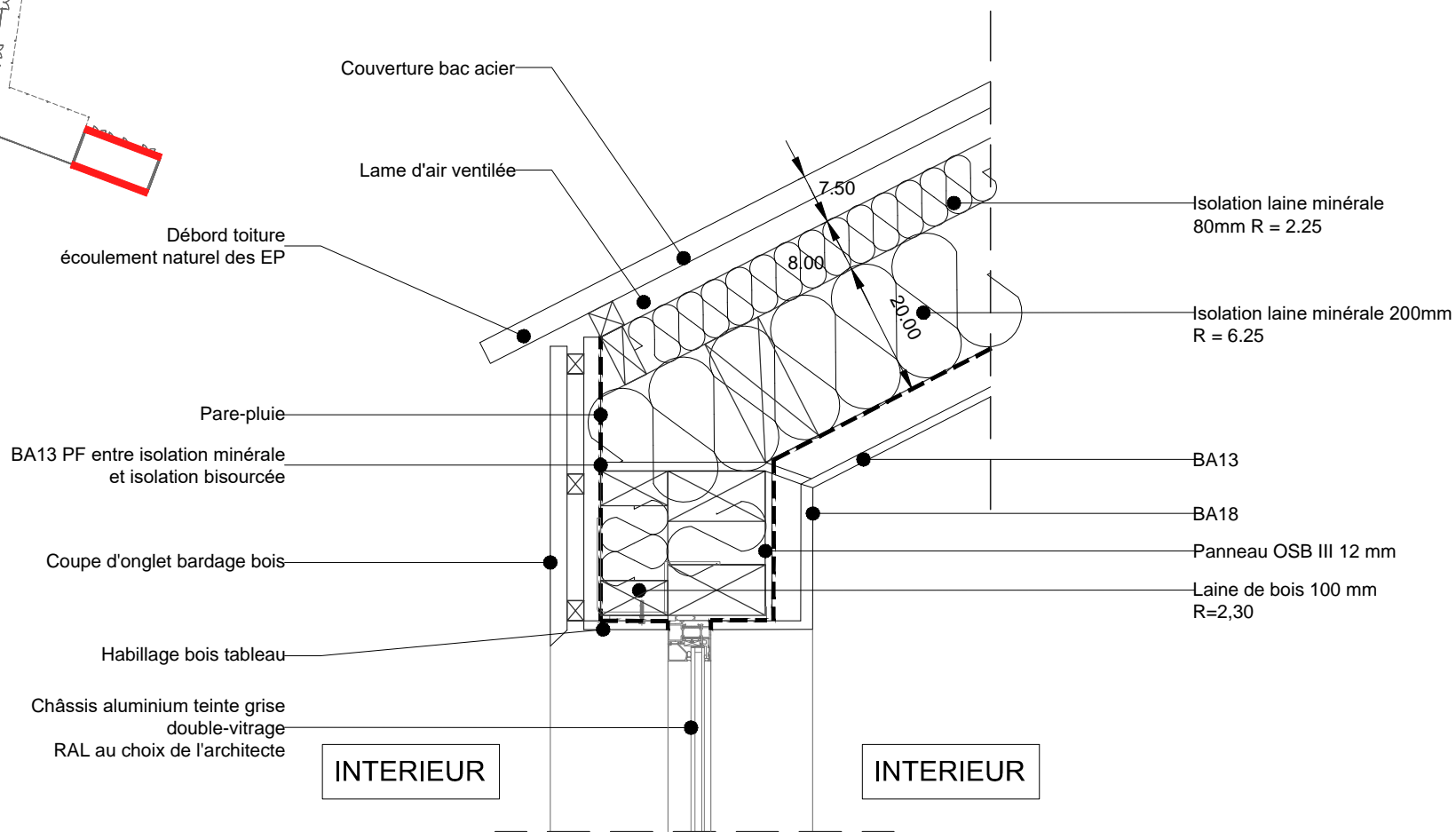
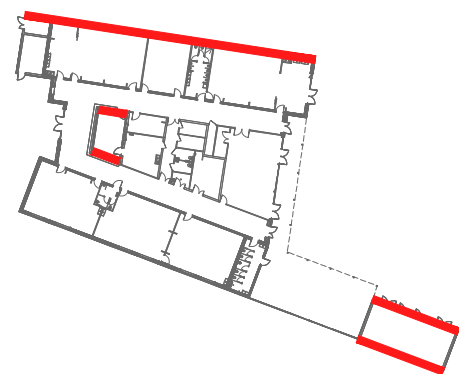

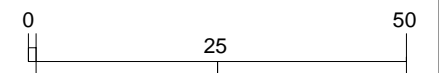
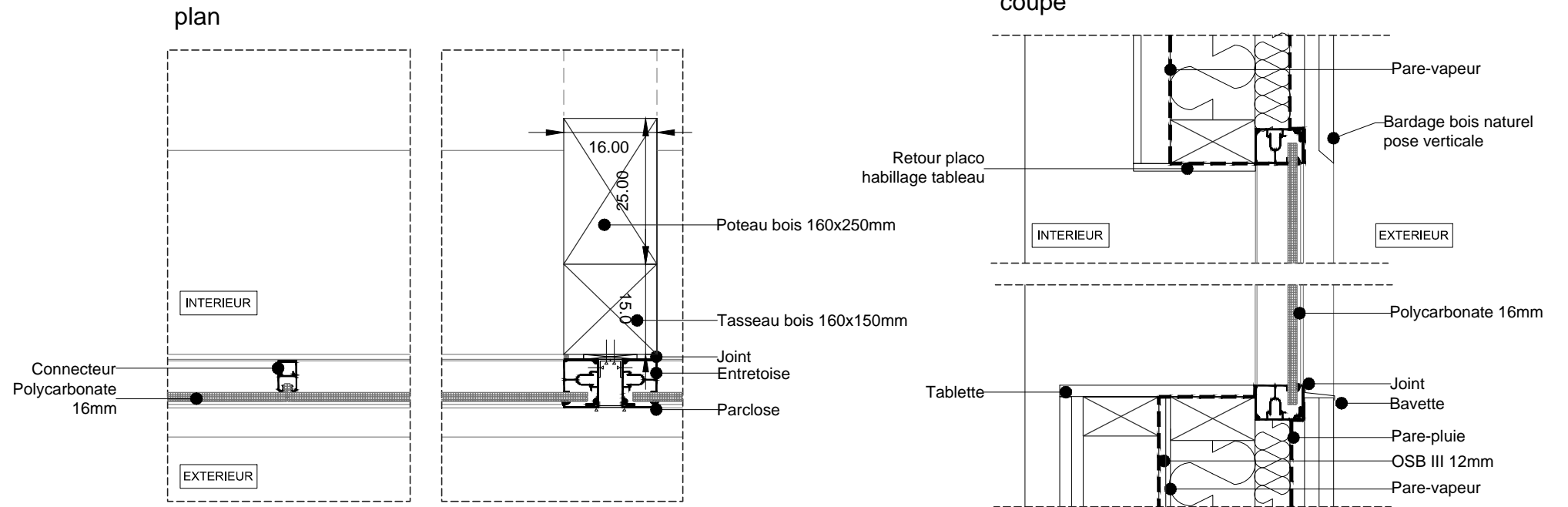

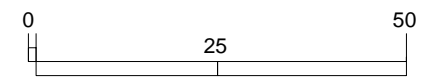
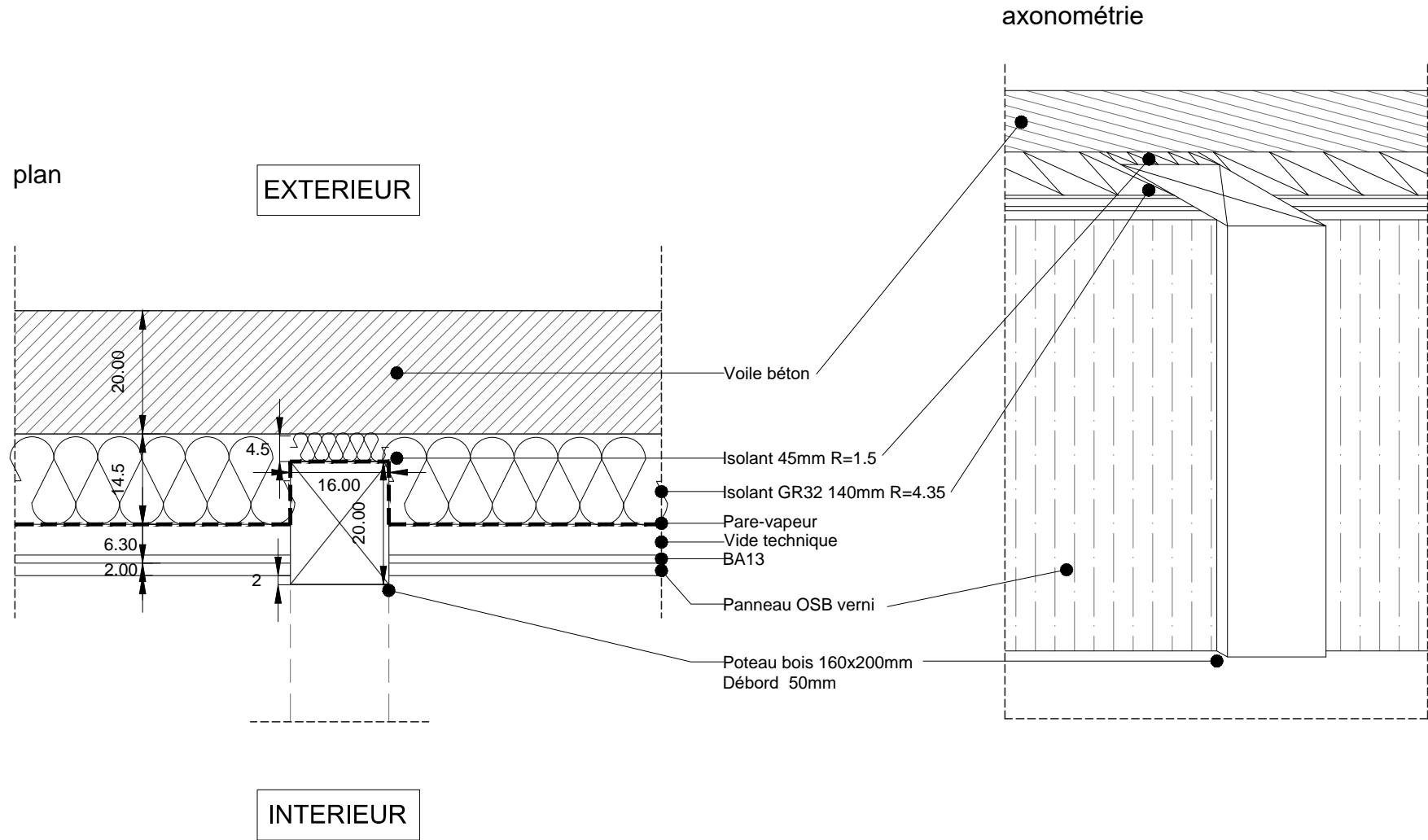

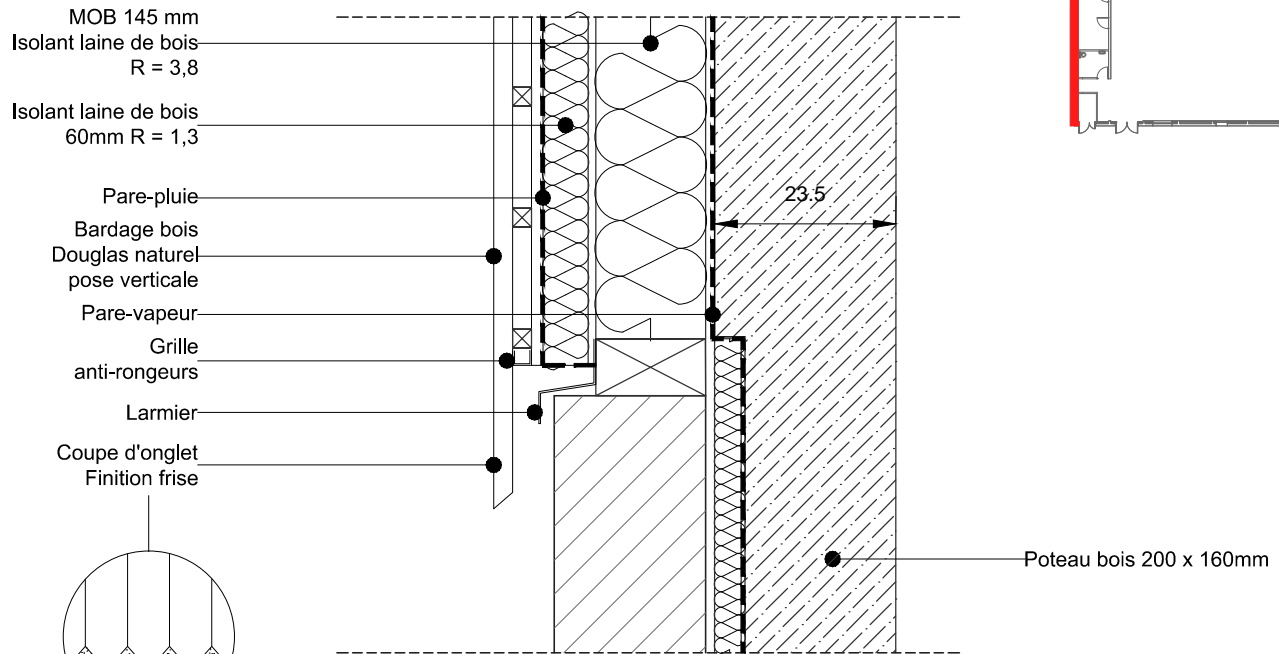

Protection tête
relevé d'étanchéité
(bande solin)

EXTERIEUR

INTERIEUR

Etanchéité
multicouche

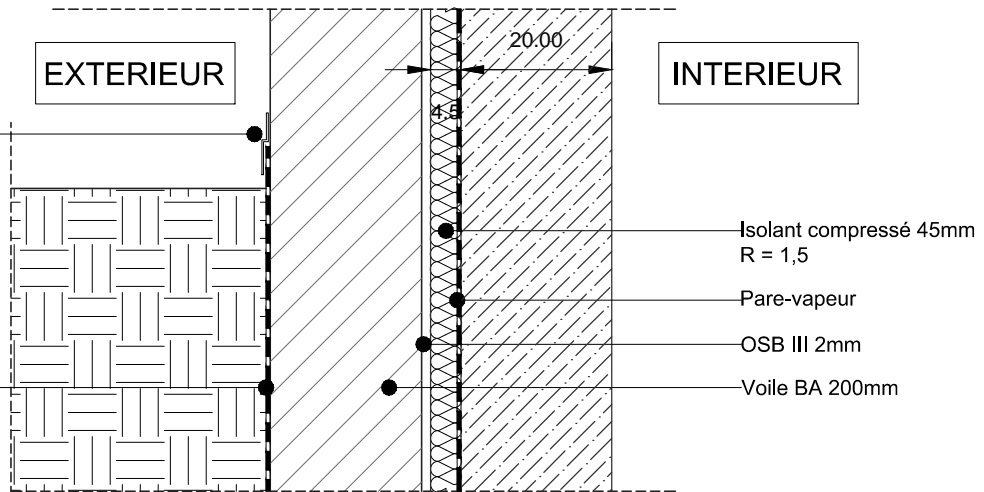

Sol béton peint

Gravillons

Drain

Isolant 160mm
R = 4,2

