

REL
PRE
AVP
APD
DP
DCE → Dossier de Consultation des Entreprises
EXE
DOE

Caves Louis de Grenelles
Réaménagement et réagencement
de la boutique d'accueil
Saumur - 49

DOCUMENTS GRAPHIQUES



Carnet de détails

DCE
daté du 30 Nov. 2017
modifié le 14.12.2017
n°002

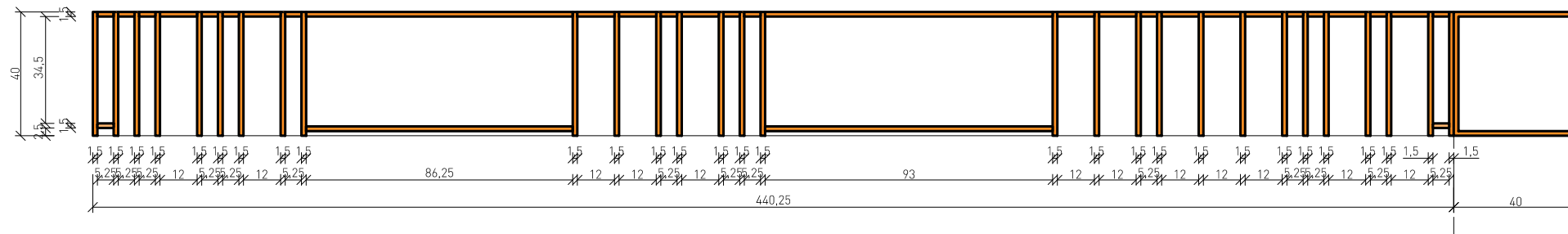
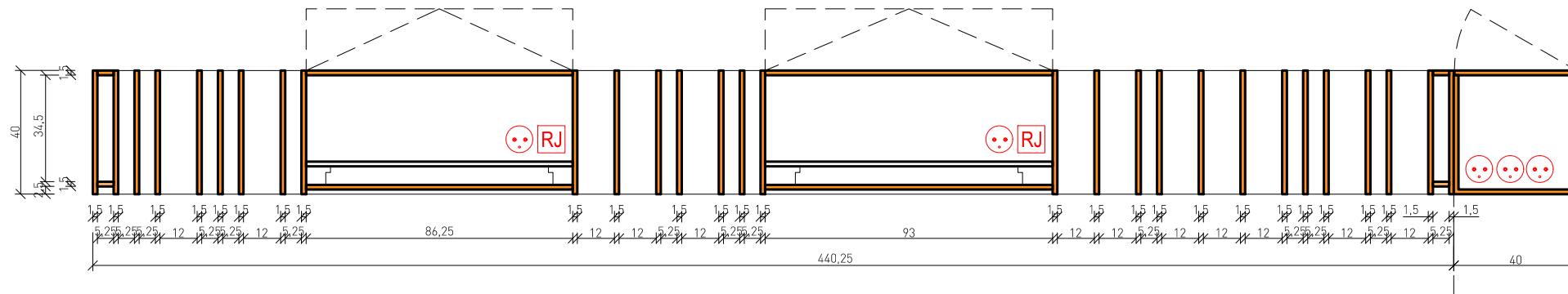

DC
 daté du 30 Nov. 21
 modifié le 05 Janv. 22

Page 01 /

ATOME
 sarl d'architecture

45bis rue Beaurepaire
 49400 SAUMUR
 SIRET 442 200 952 00053 - APE 7111Z
 Ordre National des Architectes - S05212

Détail mobilier A I 1/20

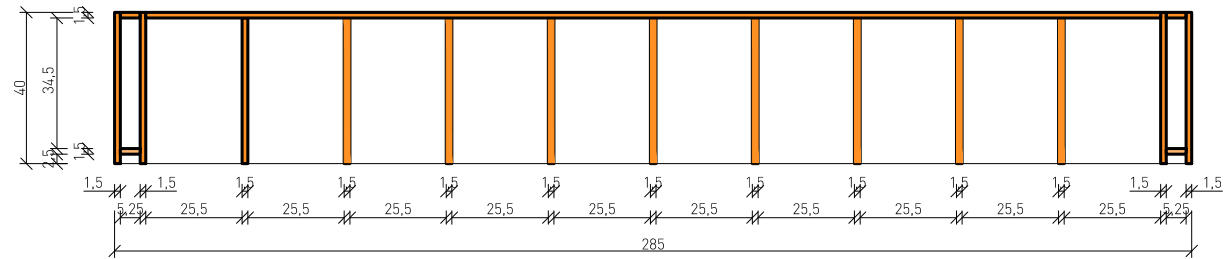
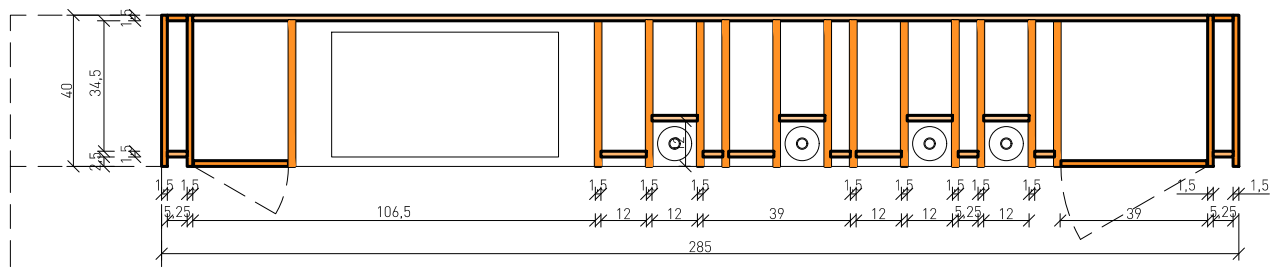

Détail alignement mobilier B&H I 1/20

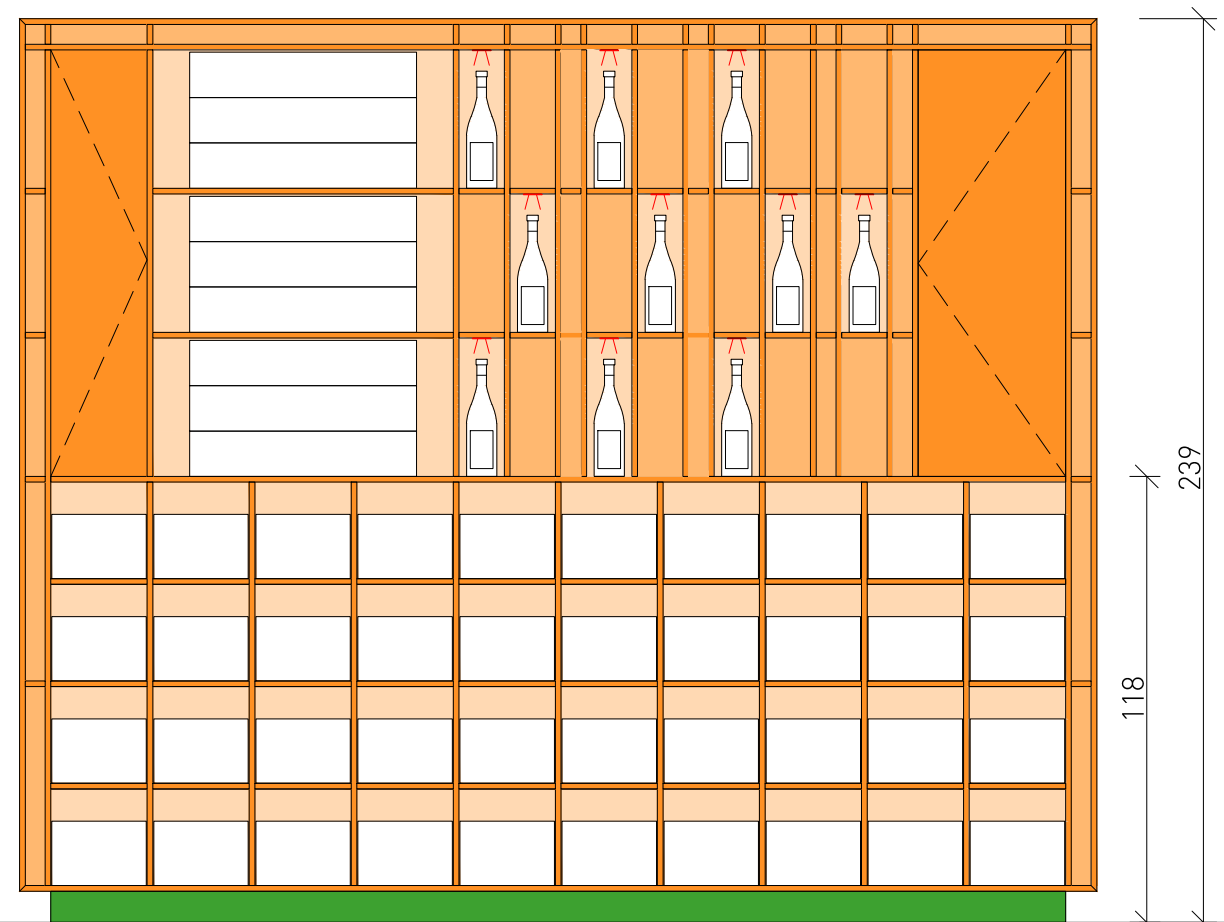

DC
daté du 30 Nov. 21
modifié le 05 Janv. 22

Page 02 /

ATOME
sarl d'architecture

45bis rue Beaurepaire
49400 SAUMUR
SIRET 442 200 952 00053 - APE 7111Z
Ordre National des Architectes - S05212

Détail mobilier B I 1/20

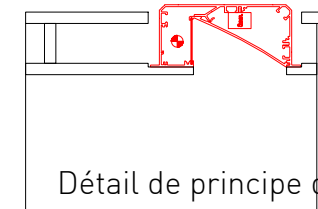
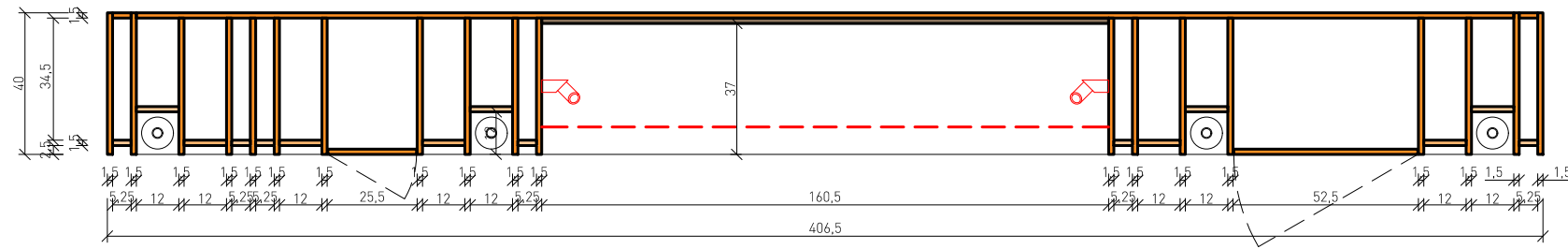

Détail de principe d'implantation du bandeau led
la position définitive sera arrêtée après test d'éclairage

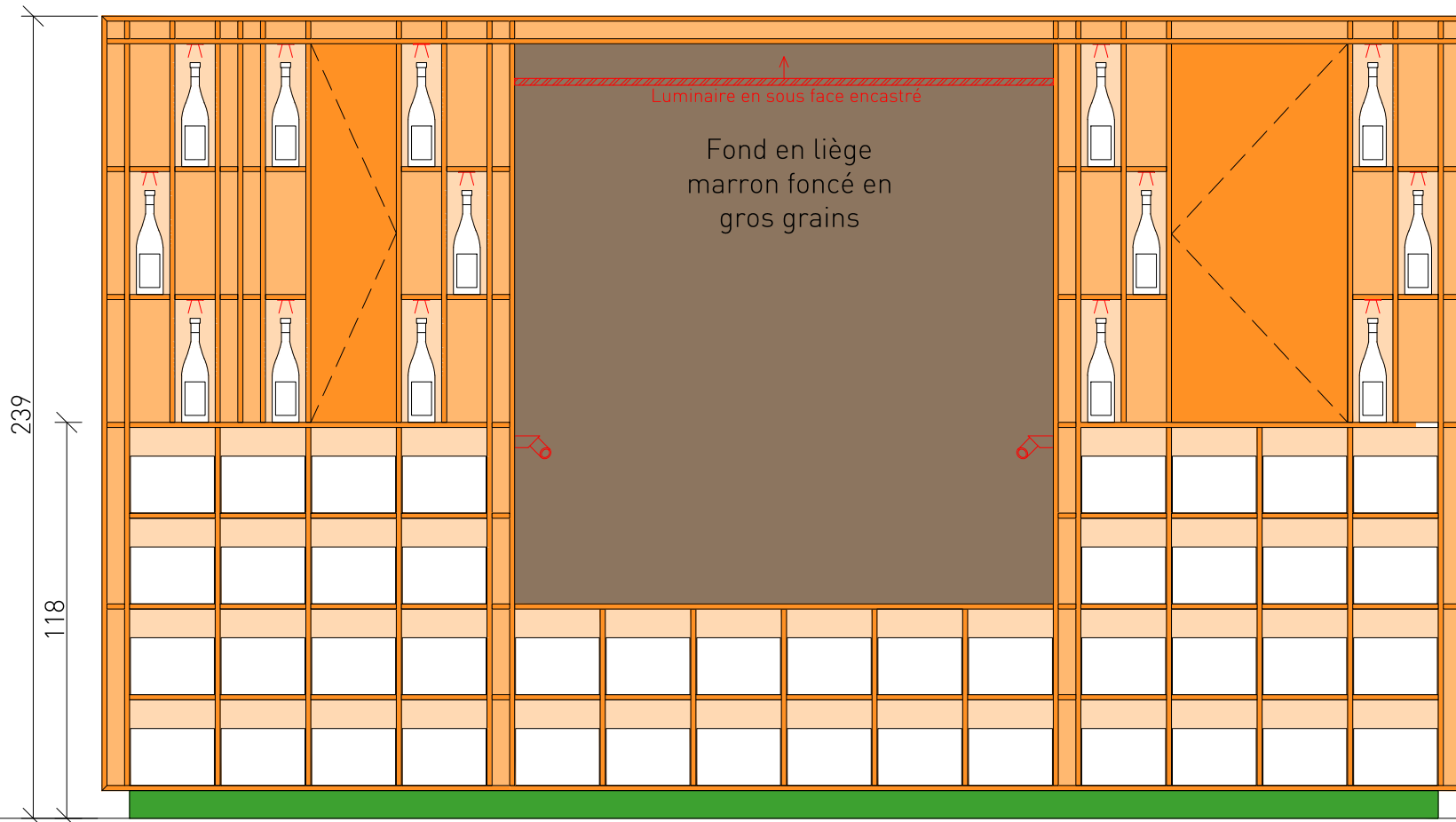
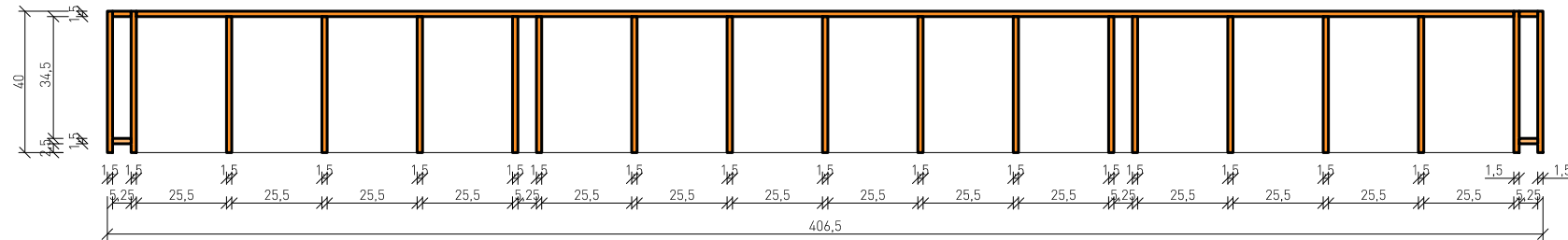

DC
daté du 30 Nov. 21
modifié le 05 Janv. 21

Page 03 /

ATOME
sarl d'architecture

45bis rue Beaurepaire
49400 SAUMUR
SIRET 442 200 952 00053 - APE 7111Z
Ordre National des Architectes - S05212

Détail mobilier C I 1/20

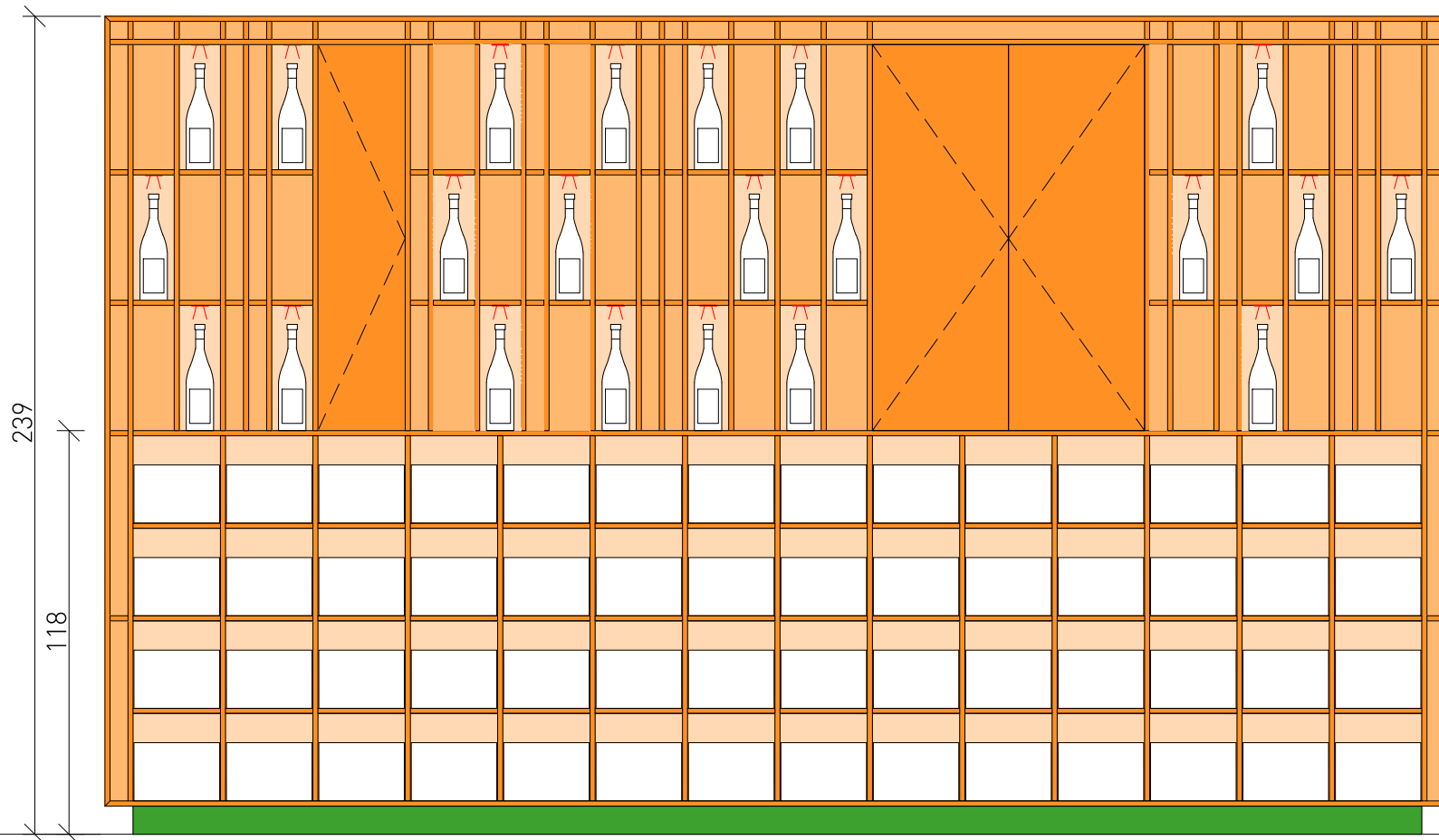
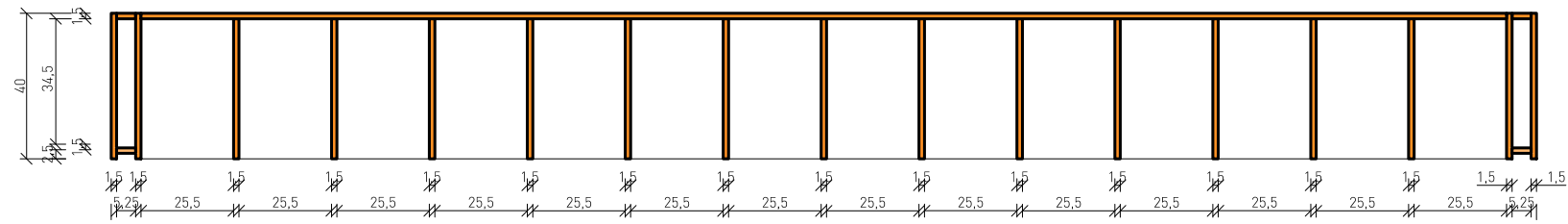
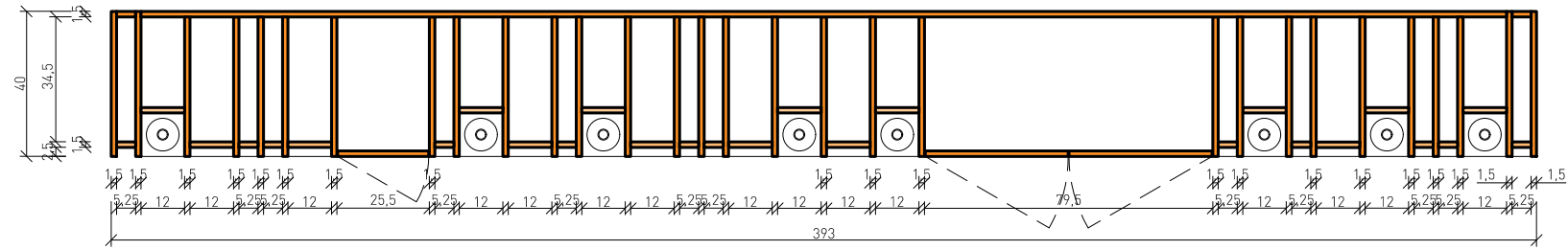

DC
 daté du 30 Nov. 20
 modifié le 05 Janv. 20
 Page 04 /

ATOME
 sarl d'architecture

 45bis rue Beaurepaire
 49400 SAUMUR
 SIRET 442 200 952 00053 - APE 7111Z
 Ordre National des Architectes - S05212

Détail mobilier D I 1/20

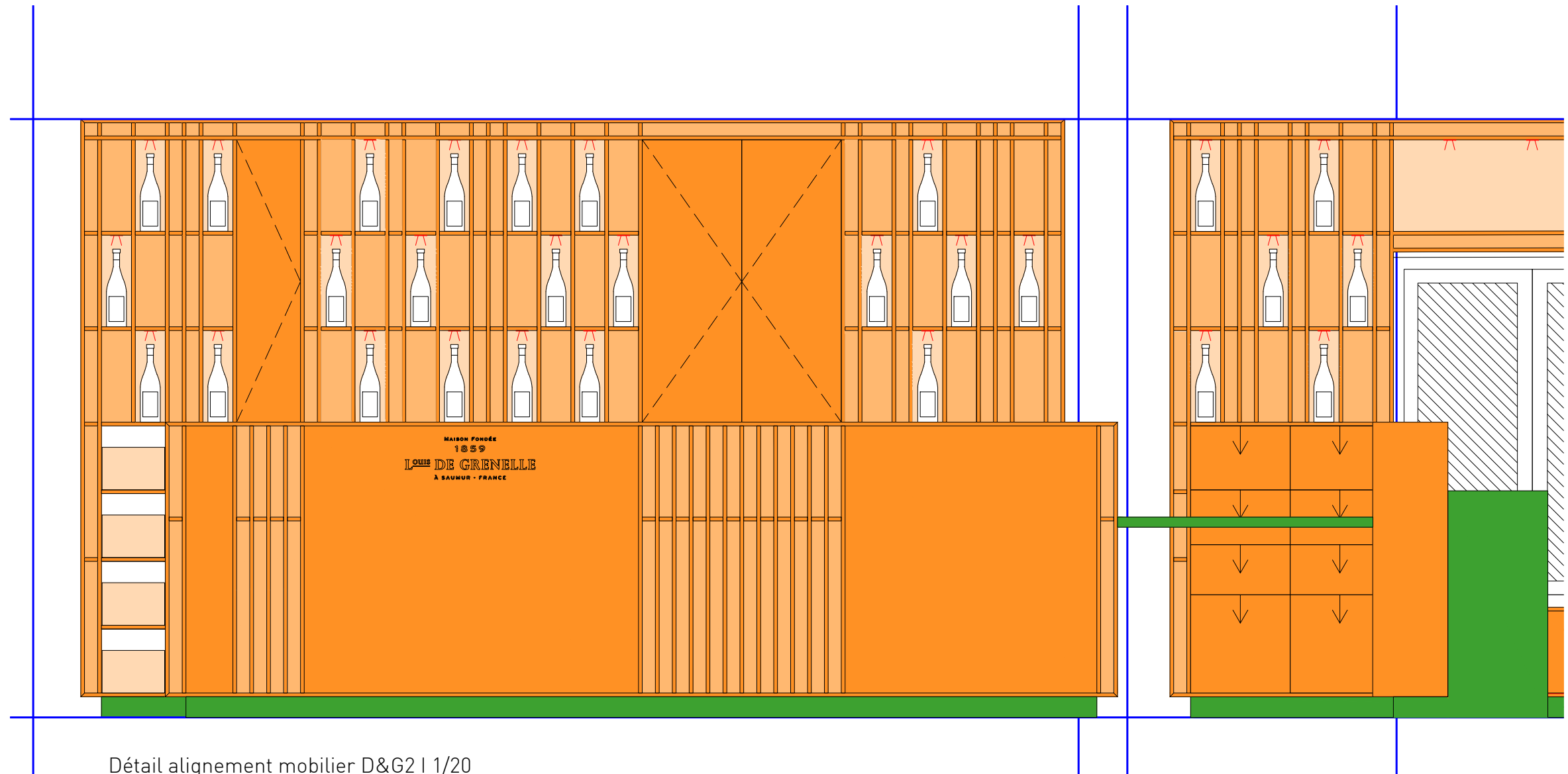

Détail alignement mobilier D&G2 | 1/20

DC
 daté du 30 Nov. 20
 modifié le 05 Janv. 20

Page 04 /

ATOME
 sarl d'architecture

Patrick Fiolleau

45bis rue Beaurepaire
 49400 SAUMUR
 SIRET 442 200 952 00053 - APE 7111Z
 Ordre National des Architectes - S05212

Détail mobilier D | 1/20

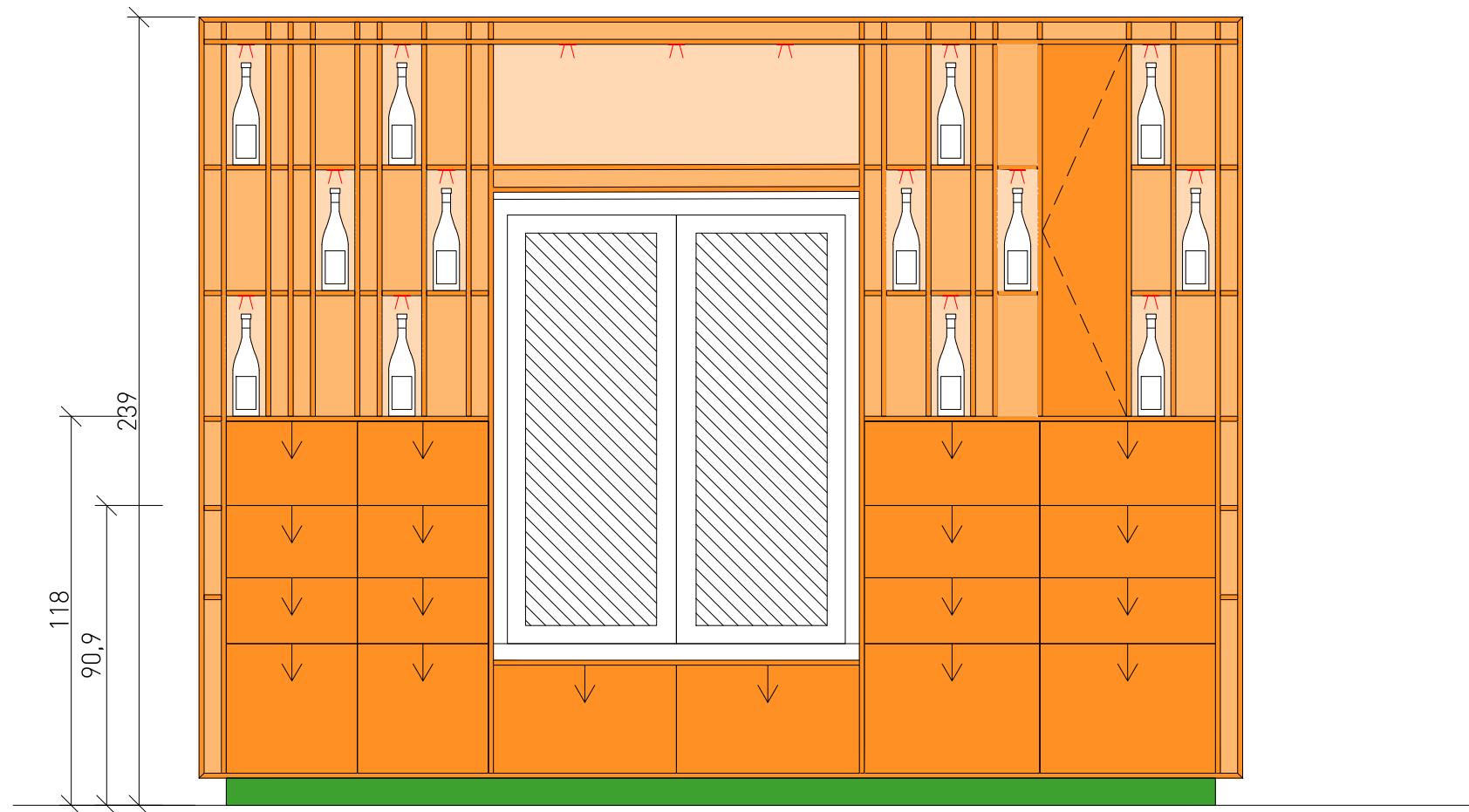
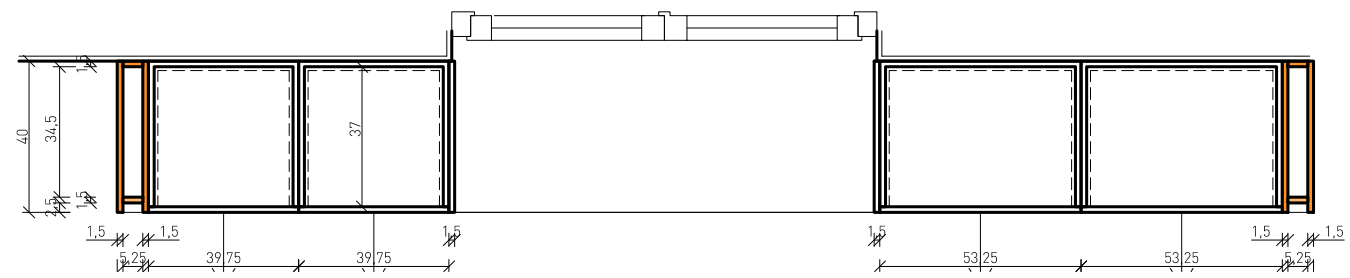
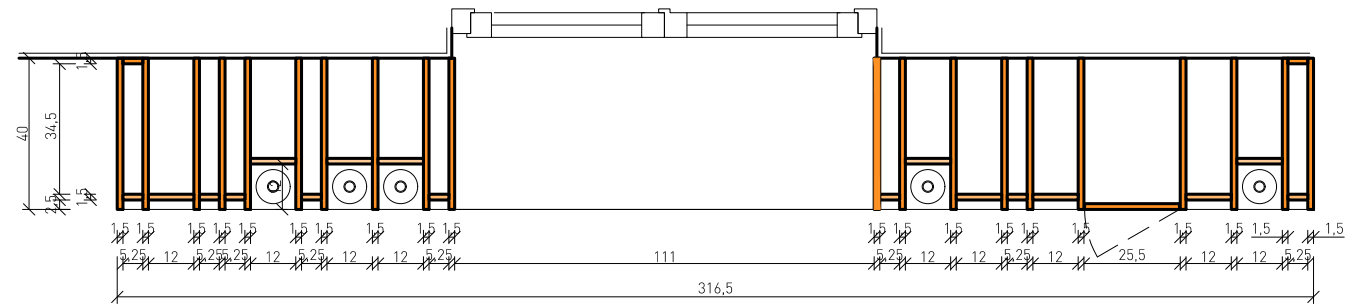

DC
 daté du 30 Nov. 20
 modifié le 05 Janv. 20

Page 05 /

ATOME
 sarl d'architecture

45bis rue Beaurepaire
 49400 SAUMUR
 SIRET 442 200 952 00053 - APE 7111Z
 Ordre National des Architectes - S05212

Détail mobilier E I 1/20

Sarl d'Architecture
 Ordre National des Architectes S05212
 Siret 44220095200053 APE 71 11Z
 TVA intracommunautaire FR 22 442 200 952 00061
 www.atome-architectes.fr

Pays de la Loire
 Patrick FIOLEAU Architecte dplg
 45bis rue Beaurepaire 49400 SAUMUR
 02 41 52 61 69
 atome.saumur@architectes.org

Bretagne
 Arnaud METTELET Architecte dplg
 14 rue Toulbroch 56000 VANNES
 02 97 58 81 37
 atome.vannes@architectes.org

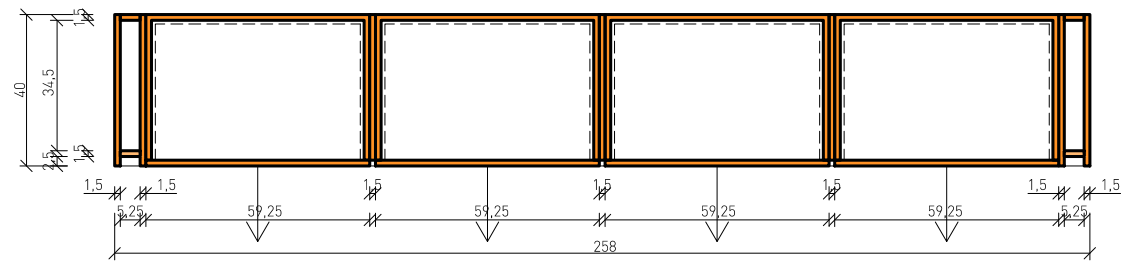
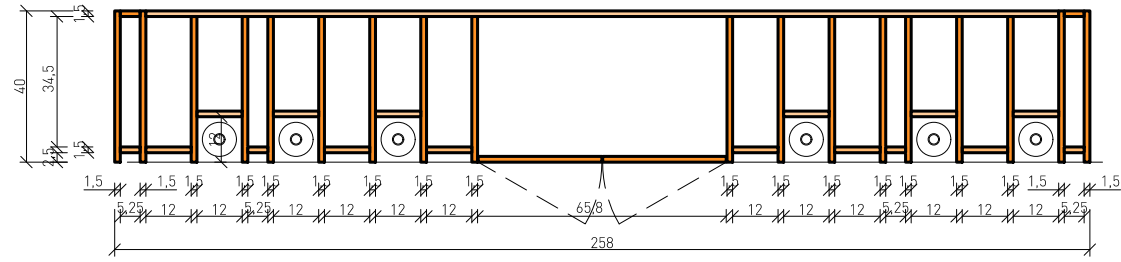

Alignement sur dessus le bas du rampant

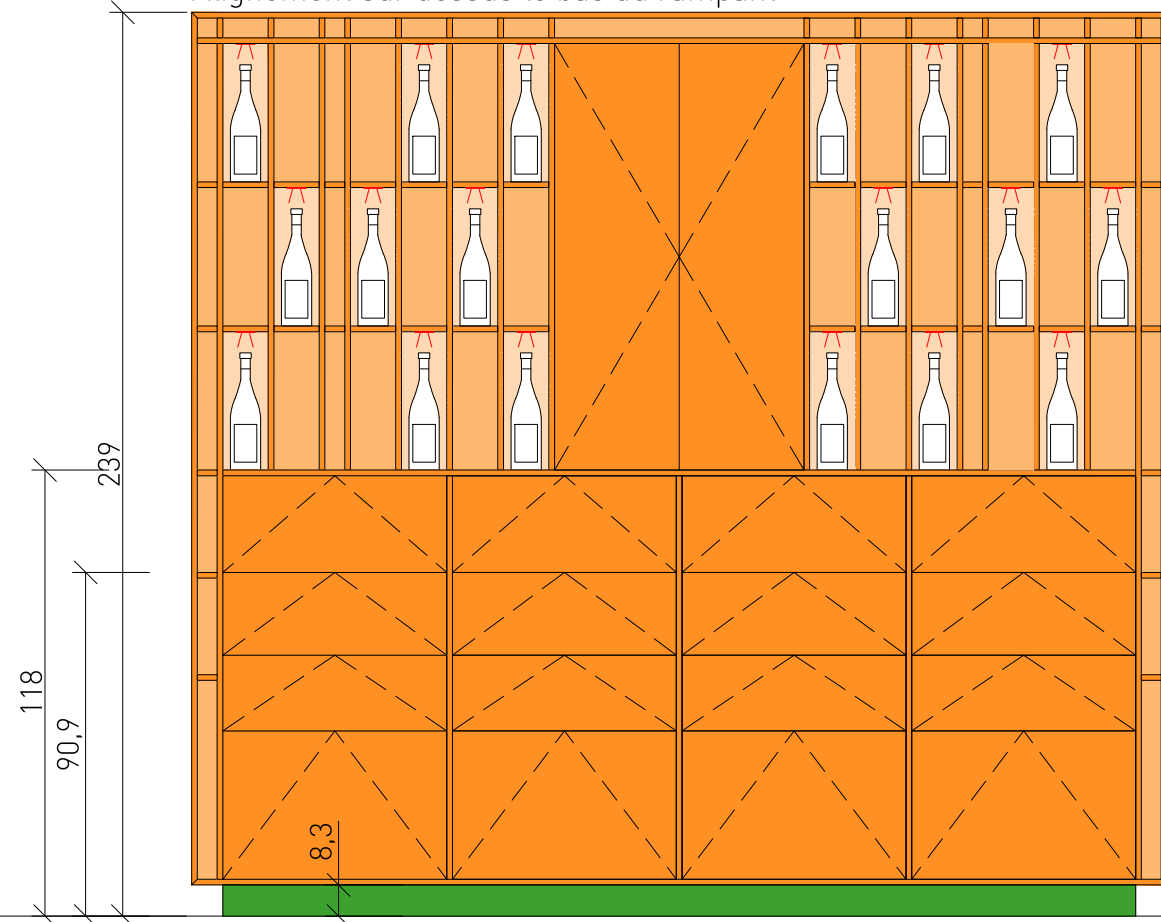

Mobilier F

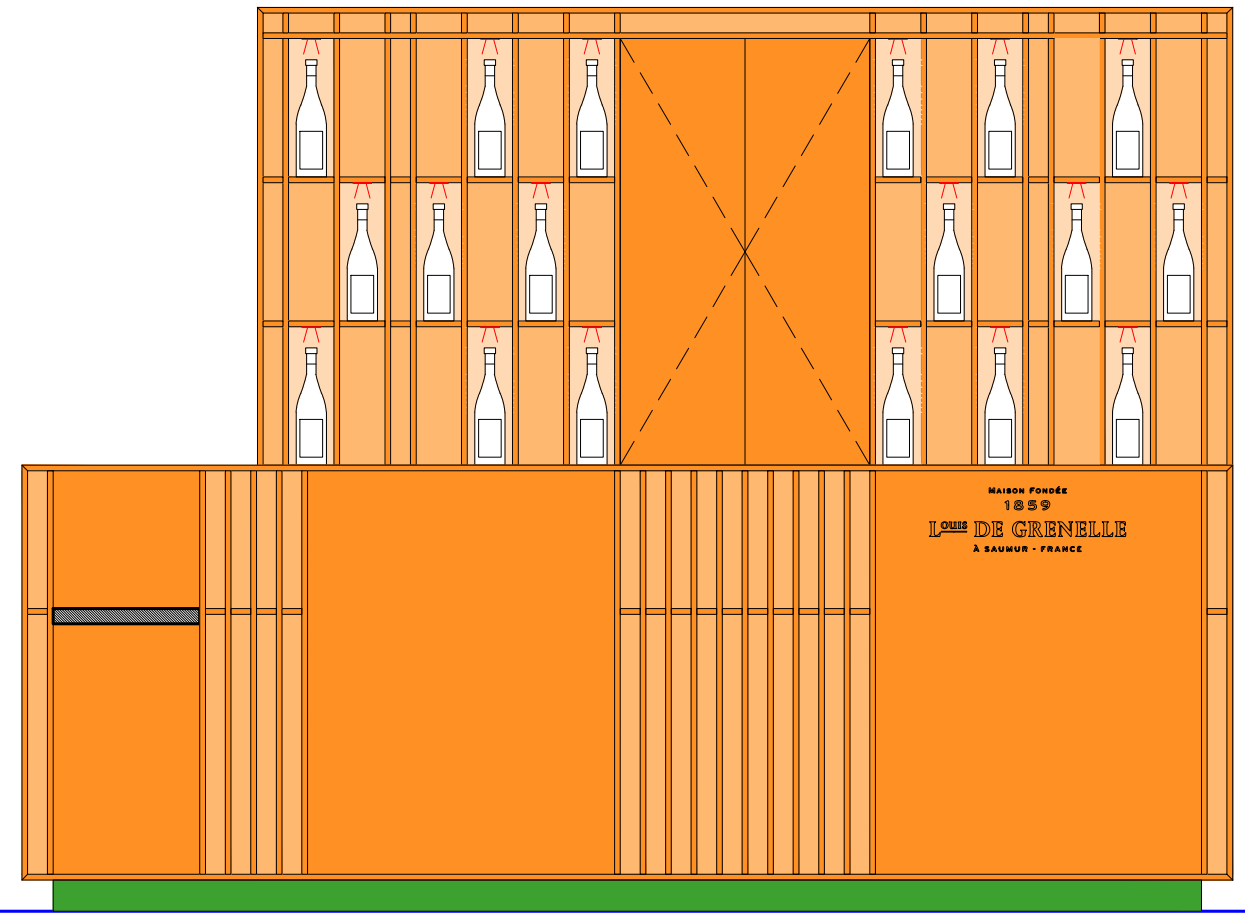

Détail alignement mobilier F&G1 | 1/20

DC
daté du 30 Nov. 21
modifié le 05 Janv. 22

Page 06 /

ATOME
sarl d'architecture

45bis rue Beaurepaire
49400 SAUMUR
SIRET 442 200 952 00053 - APE 7111Z
Ordre National des Architectes - S05212

Détail mobilier F&L | 1/20

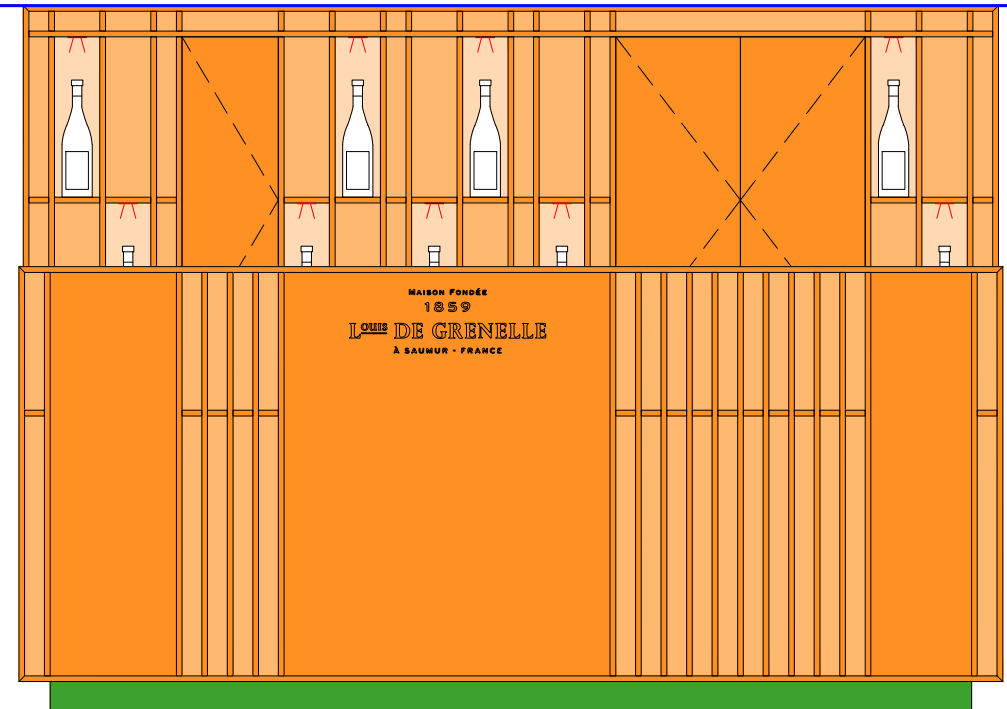
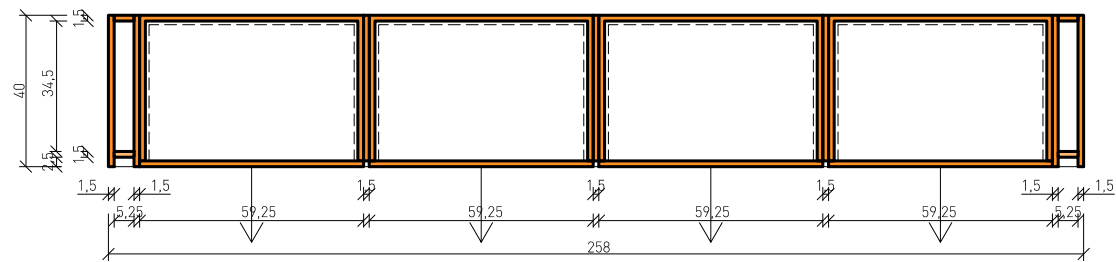
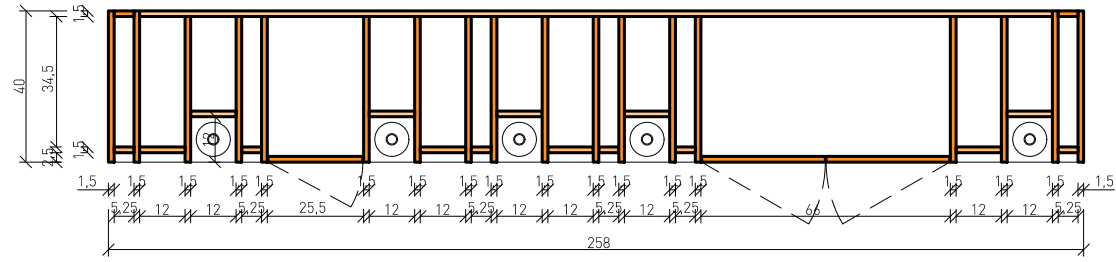

Détail alignement mobilier L&K I 1/20

Alignement sur dessus le bas du rampant

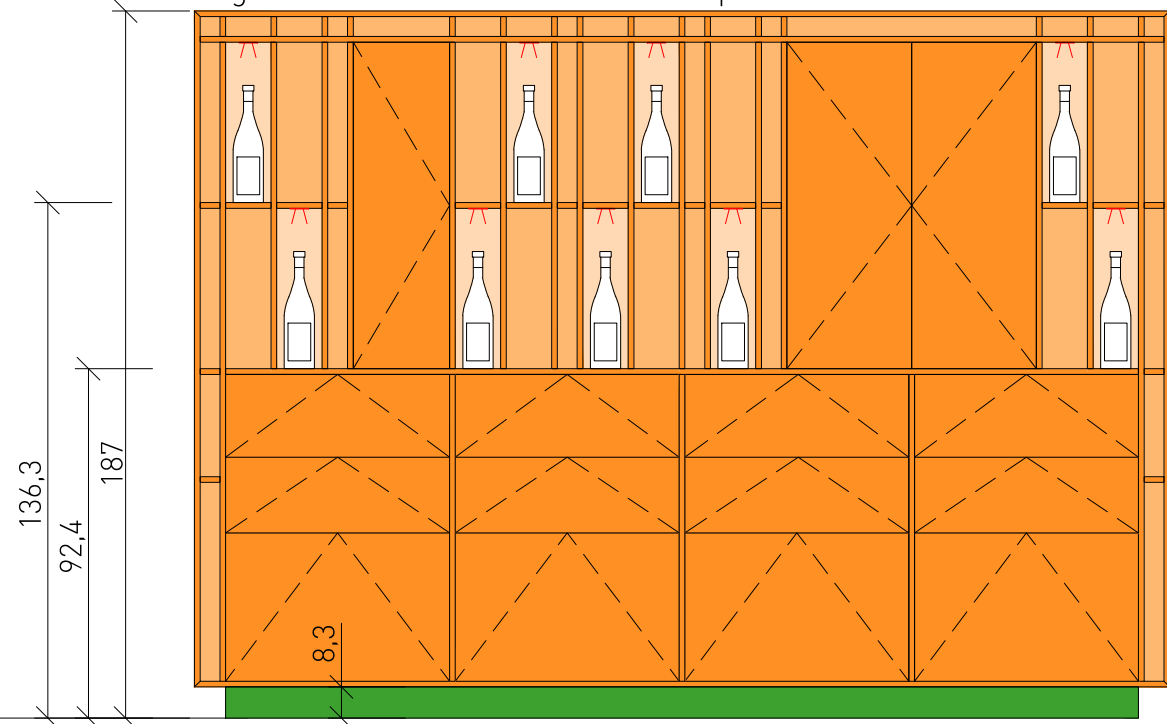

Mobilier L

DC
daté du 30 Nov. 20
modifié le 05 Janv. 20

Page 06 /

ATOME
sarl d'architecture

45bis rue Beaurepaire
49400 SAUMUR
SIRET 442 200 952 00053 - APE 7111Z
Ordre National des Architectes - S05212

Détail mobilier L I 1/20

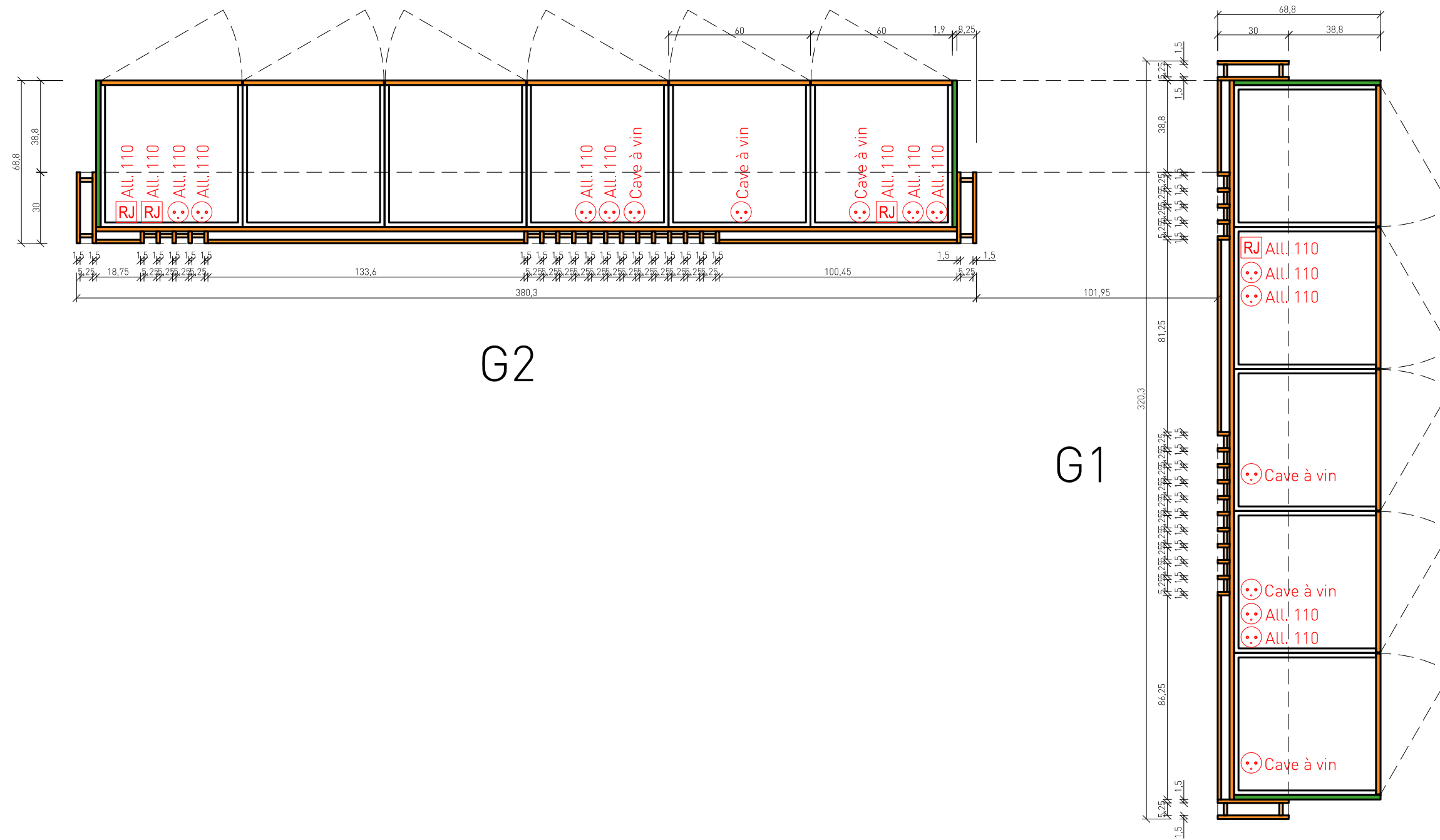

DC
 daté du 30 Nov. 21
 modifié le 05 Janv. 22

Page 07 /

ATOME
 sarl d'architecture

45bis rue Beaurepaire
 49400 SAUMUR
 SIRET 442 200 952 00053 - APE 7111Z
 Ordre National des Architectes - S05212

Détail mobilier G1 & G2 | 1/20

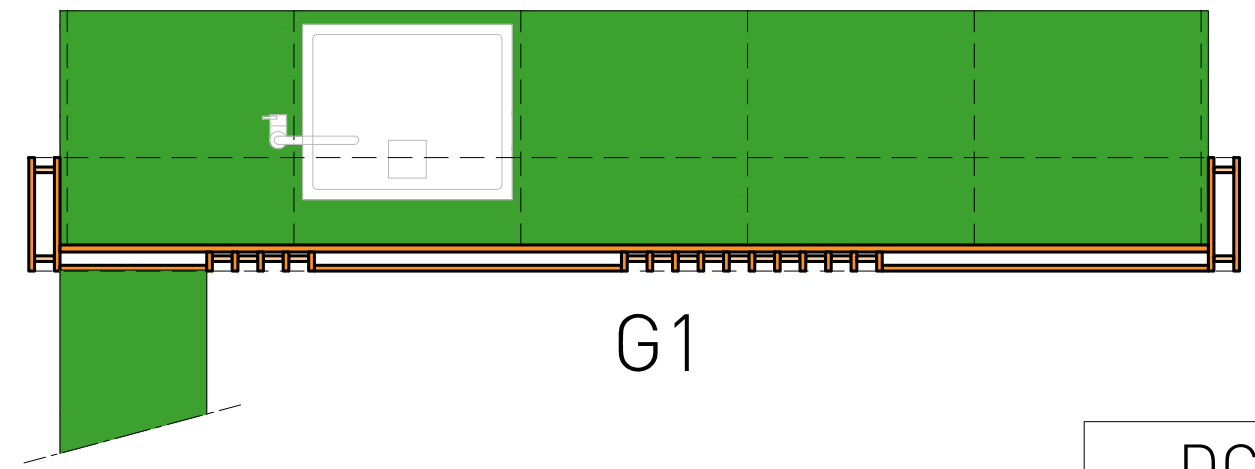
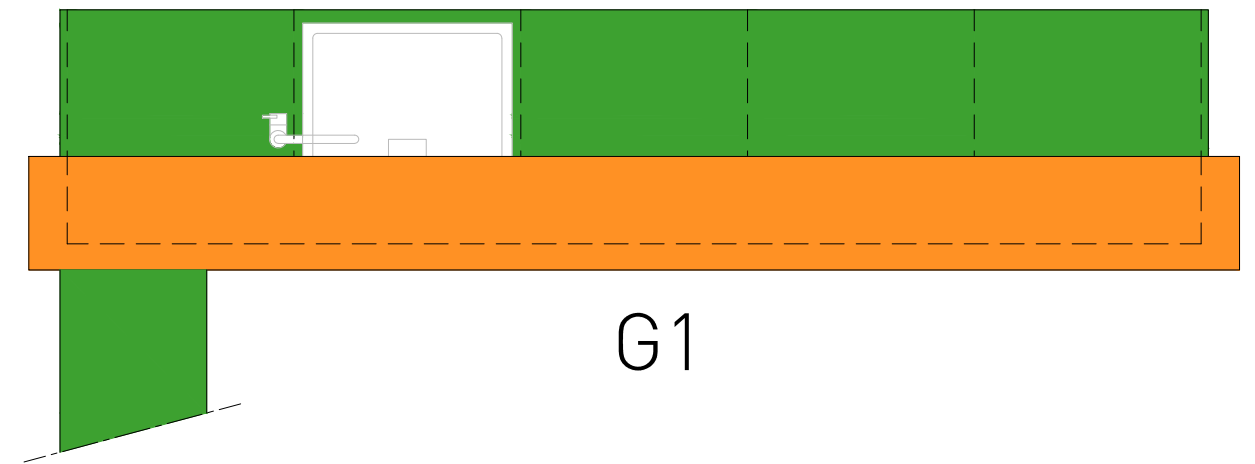
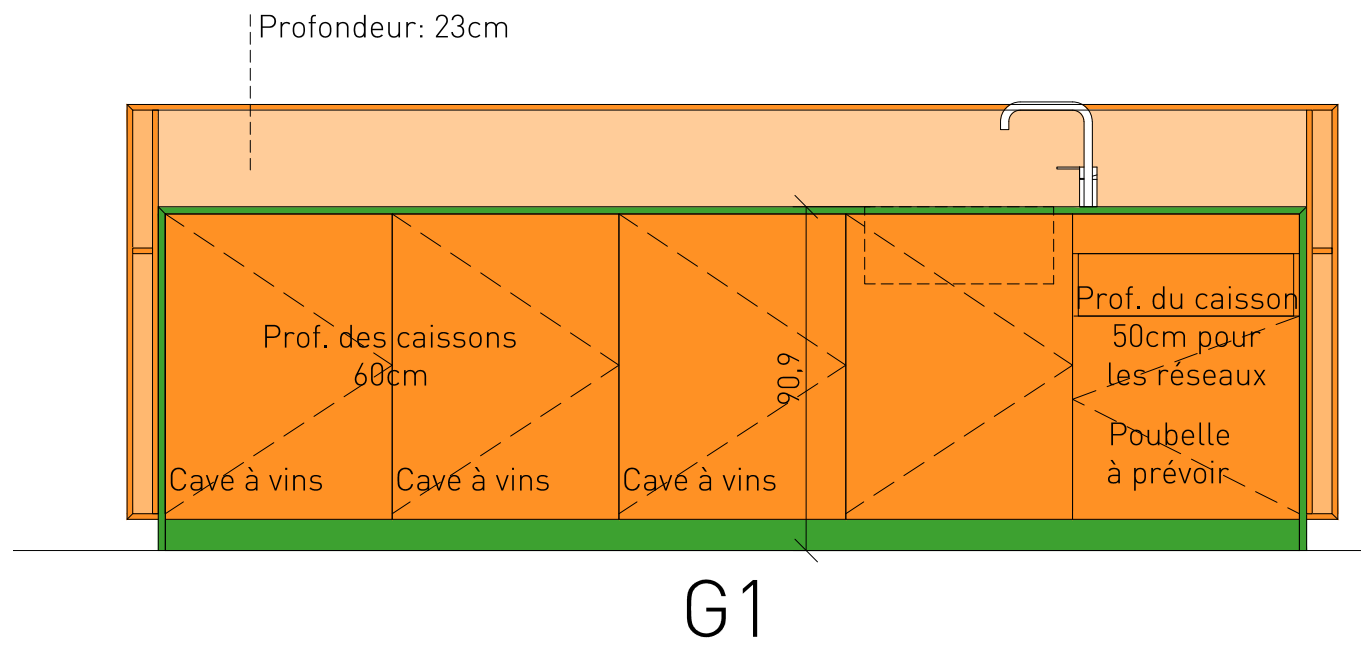
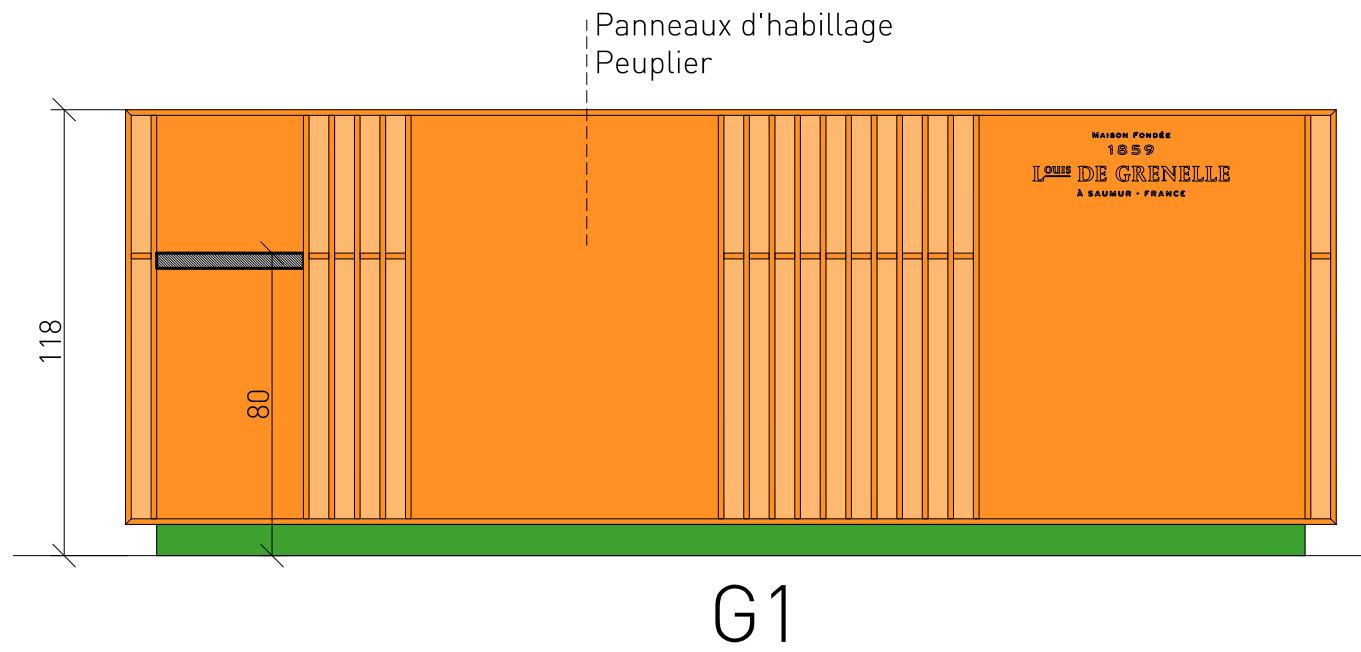

DC
daté du 30 Nov. 20
modifié le 05 Janv. 20

Page 08 /

ATOME
sarl d'architecture

45bis rue Beaurepaire
49400 SAUMUR
SIRET 442 200 952 00053 - APE 7111Z
Ordre National des Architectes - S05212

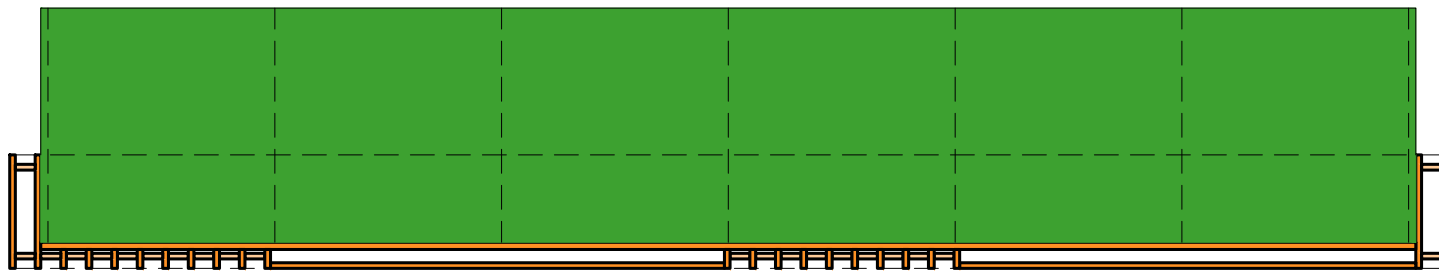
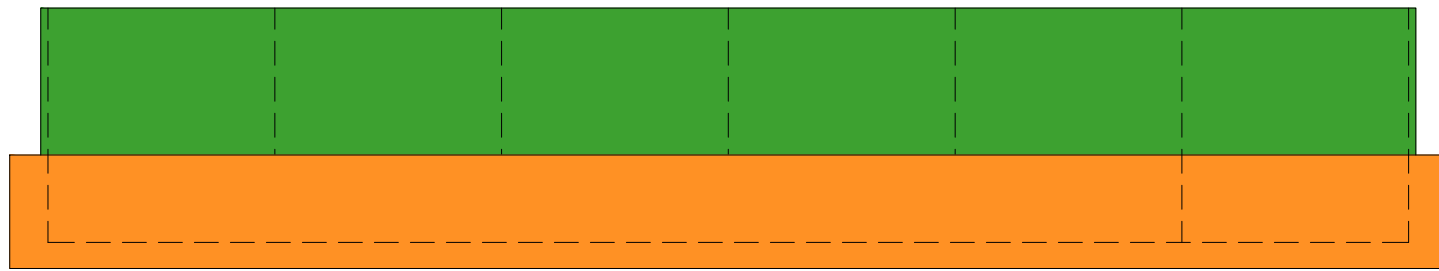

Panneaux d'habillage
Peuplier

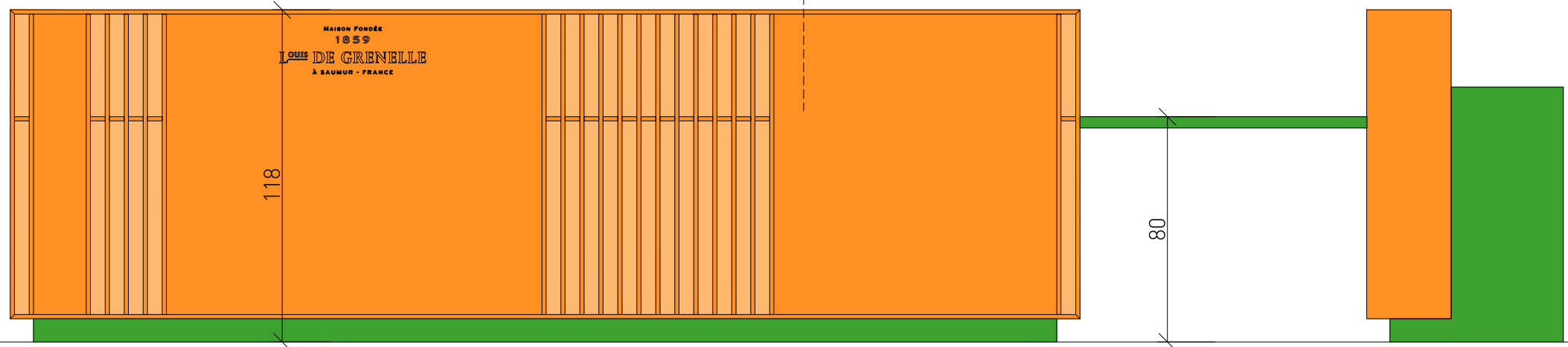

Profondeur: 23cm

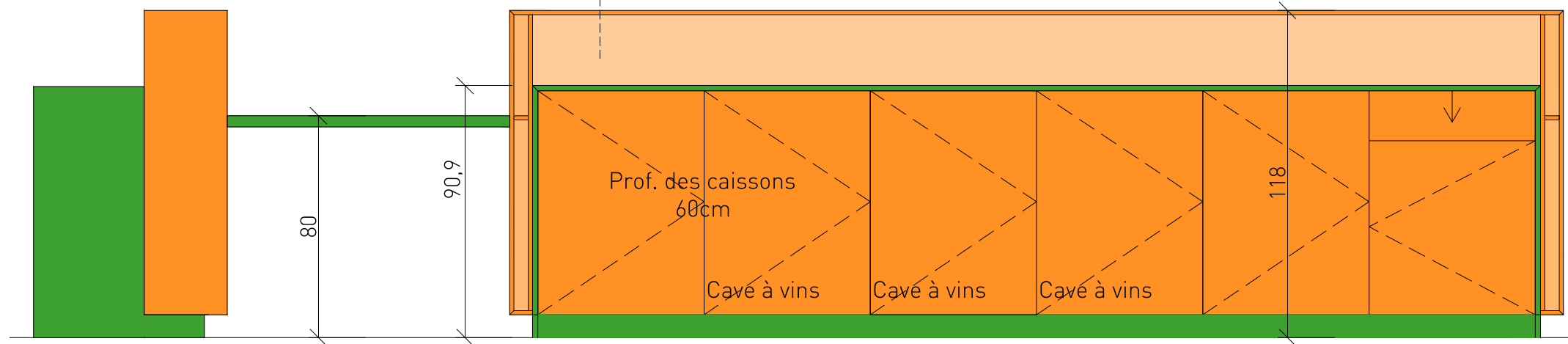

DC
daté du 30 Nov. 2021
modifié le 05 Janv. 2022
Page 09 /

ATOME
sarl d'architecture

45bis rue Beaurepaire
49400 SAUMUR
SIRET 442 200 952 00053 - APE 7111Z
Ordre National des Architectes - S05212

Détail mobilier G2 I 1/20

Sarl d'Architecture
Ordre National des Architectes S05212
Siret 44220095200053 APE 71 11Z
TVA intracommunautaire FR 22 442 200 952 00061
www.atome-architectes.fr

Pays de la Loire
Patrick FIOLEAU Architecte dplg
45bis rue Beaurepaire 49400 SAUMUR
02 41 52 61 69
atome.saumur@architectes.org

Bretagne
Arnaud METTELET Architecte dplg
14 rue Toulbroch 56000 VANNES
02 97 58 81 37
atome.vannes@architectes.org

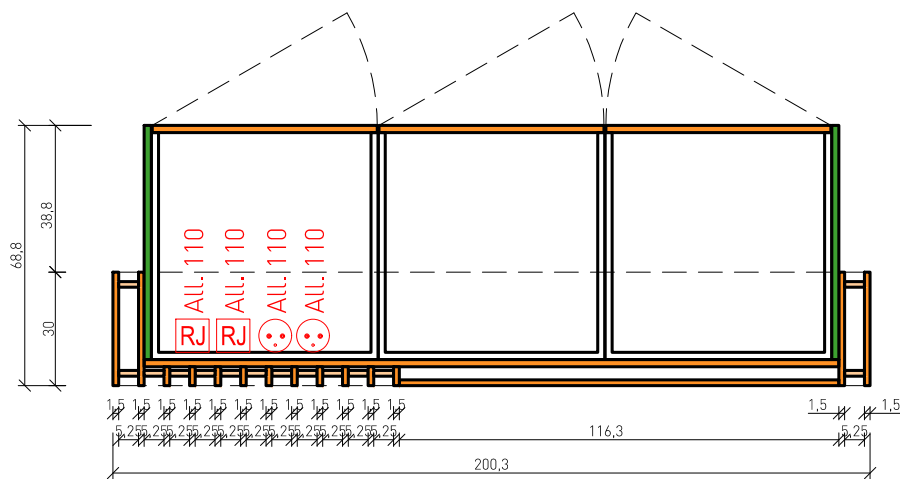
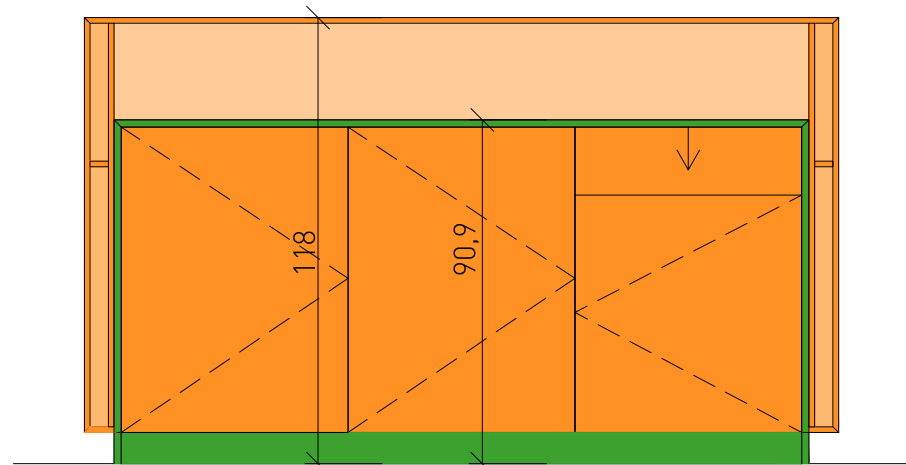
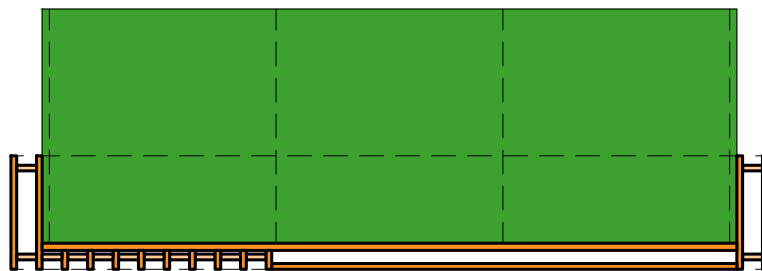
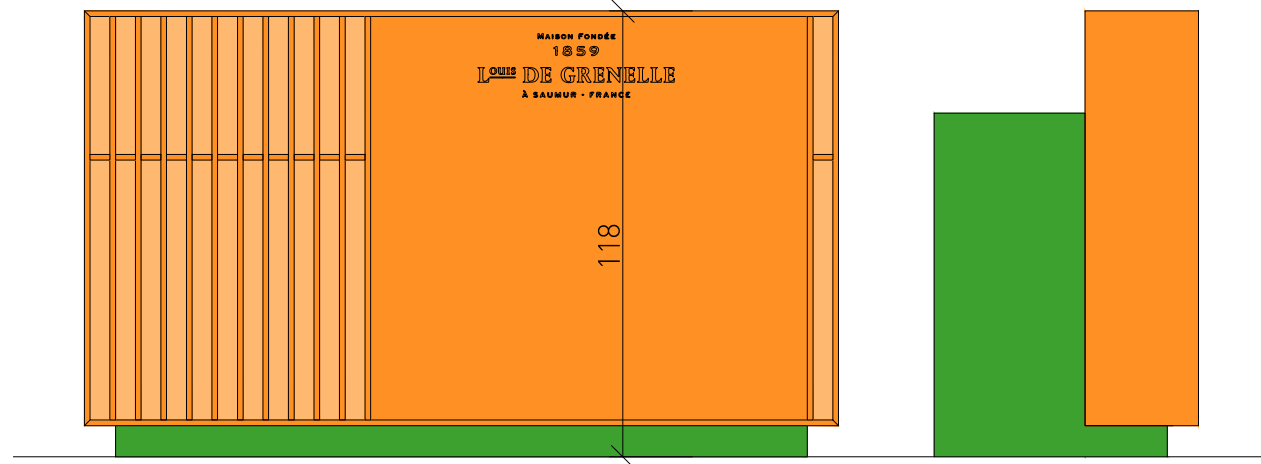
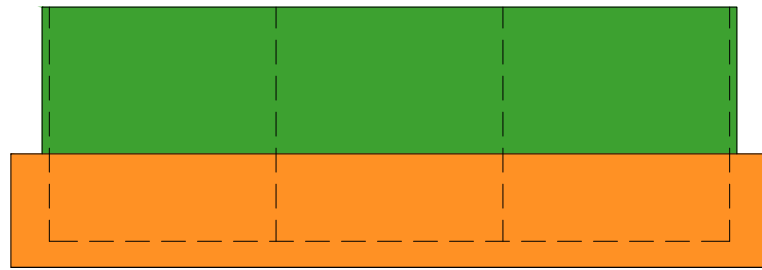

DC
 daté du 30 Nov. 2020
 modifié le 05 Janv. 2021
 Page 10 /

ATOMÉ
 sarl d'architecture

45bis rue Beaurepaire
 49400 SAUMUR
 SIRET 442 200 952 00053 - APE 7111Z
 Ordre National des Architectes - S05212

Détail mobilier H I 1/20

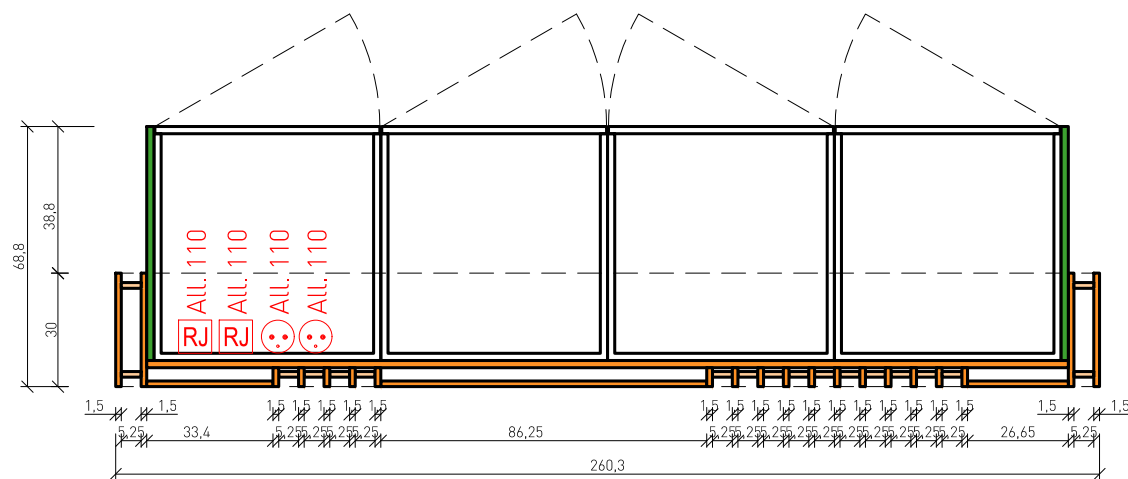
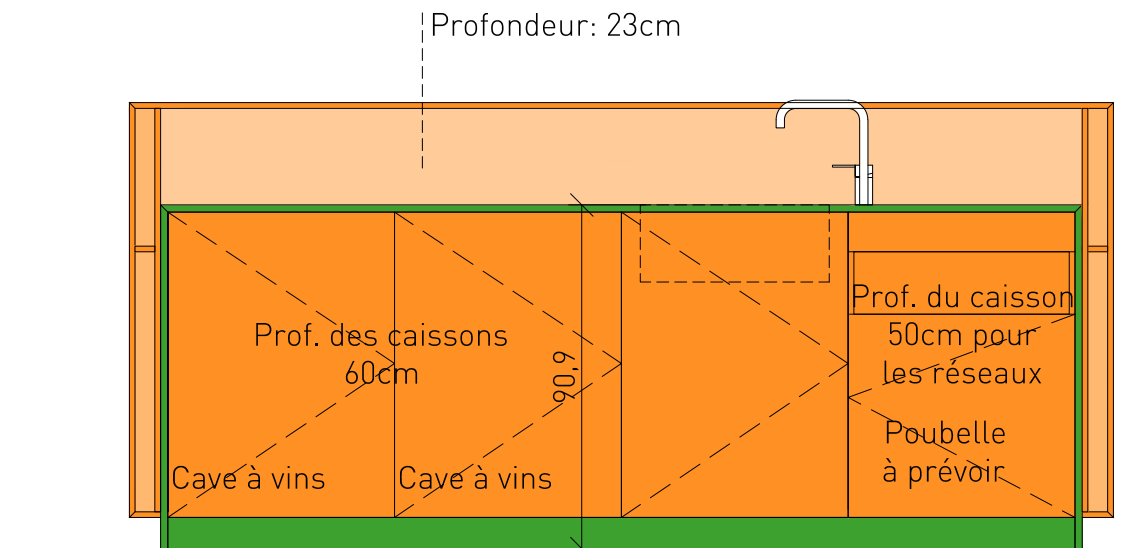
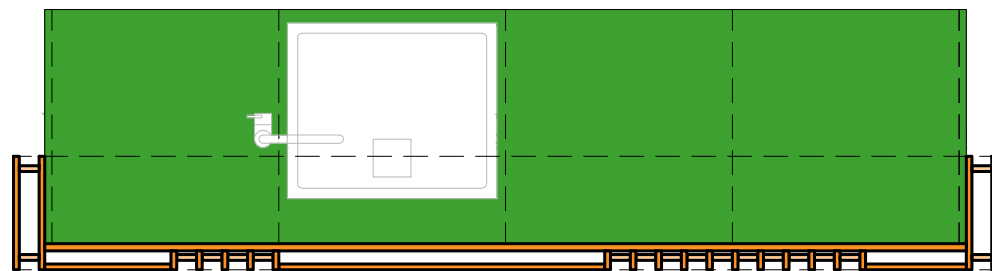
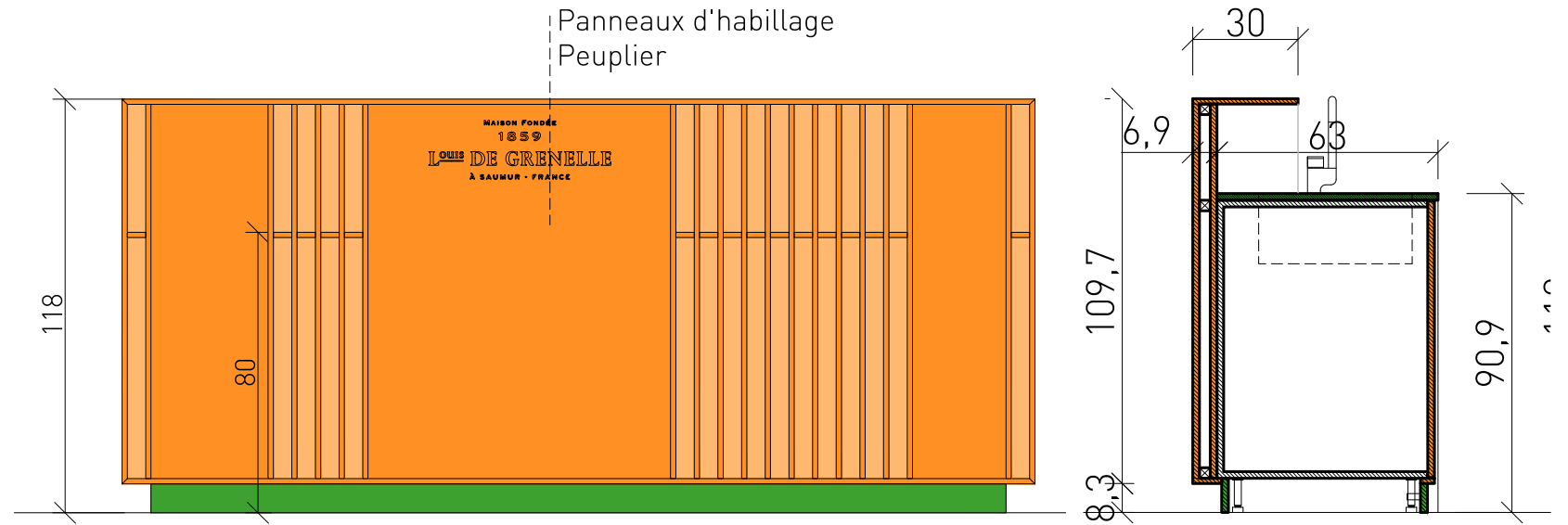
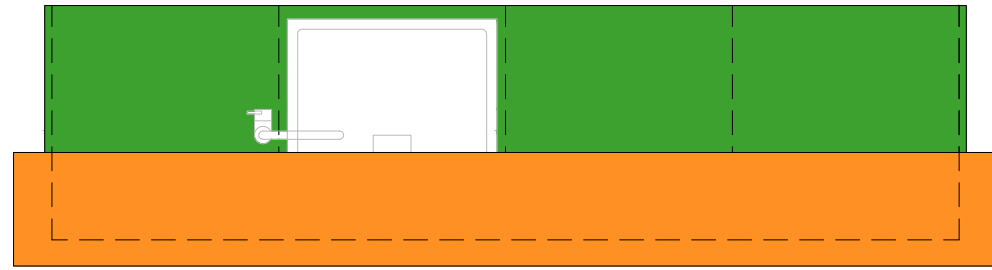

DC
daté du 30 Nov. 21
modifié le 05 Janv. 21
Page 11 /

ATOME
sarl d'architecture
45bis rue Beaurepaire
49400 SAUMUR
SIRET 442 200 952 00053 - APE 7111Z
Ordre National des Architectes - S05212

Détail mobilier K I 1/20

Sarl d'Architecture
Ordre National des Architectes S05212
Siret 44220095200053 APE 71 11Z
TVA intracommunautaire FR 22 442 200 952 00061
www.atome-architectes.fr

Pays de la Loire
Patrick FIOLEAU Architecte dplg
45bis rue Beaurepaire 49400 SAUMUR
02 41 52 61 69
atome.saumur@architectes.org

Bretagne
Arnaud METTELET Architecte dplg
14 rue Toulbroch 56000 VANNES
02 97 58 81 37
atome.vannes@architectes.org

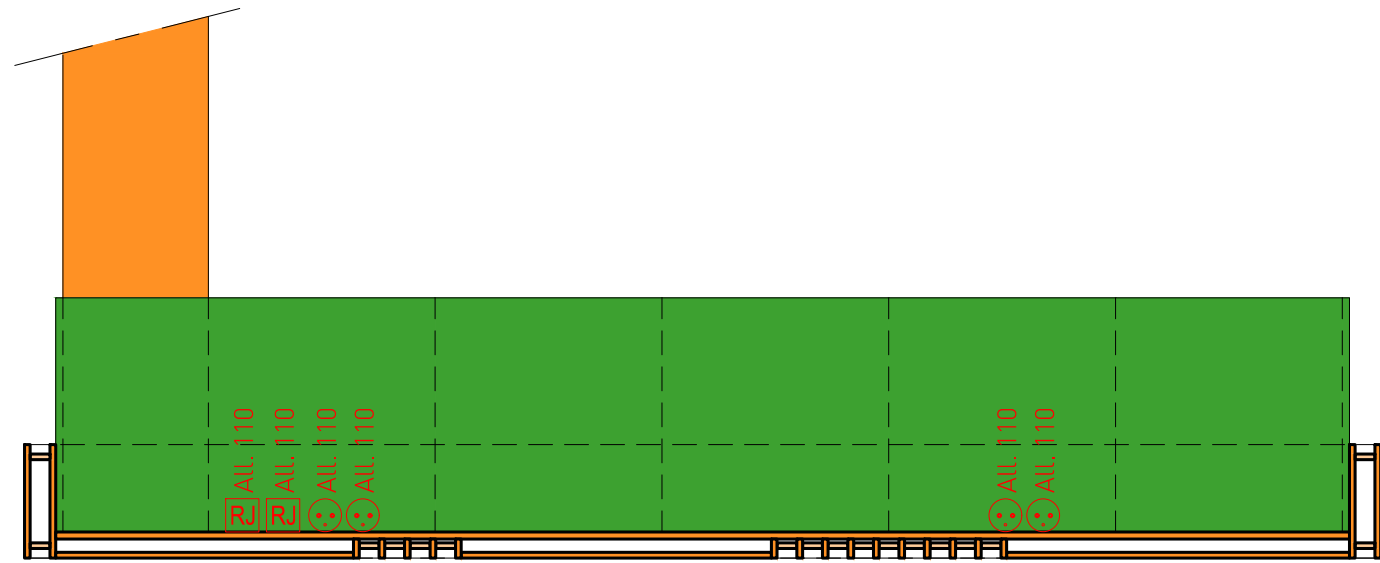
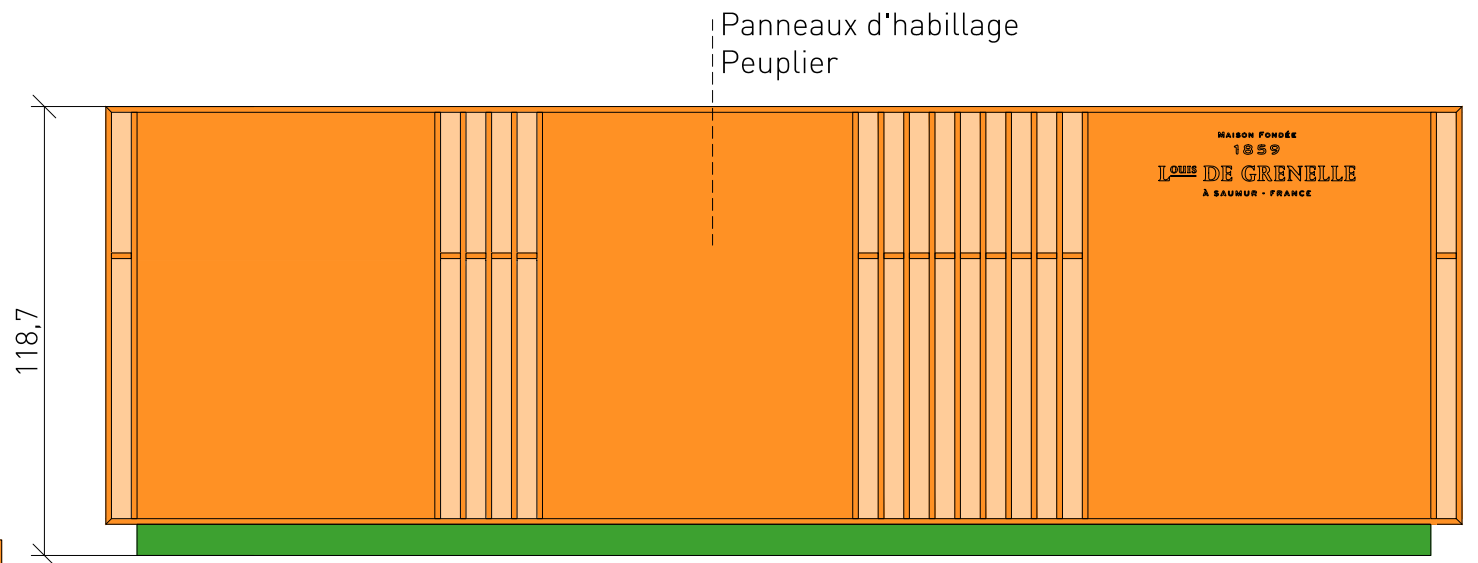
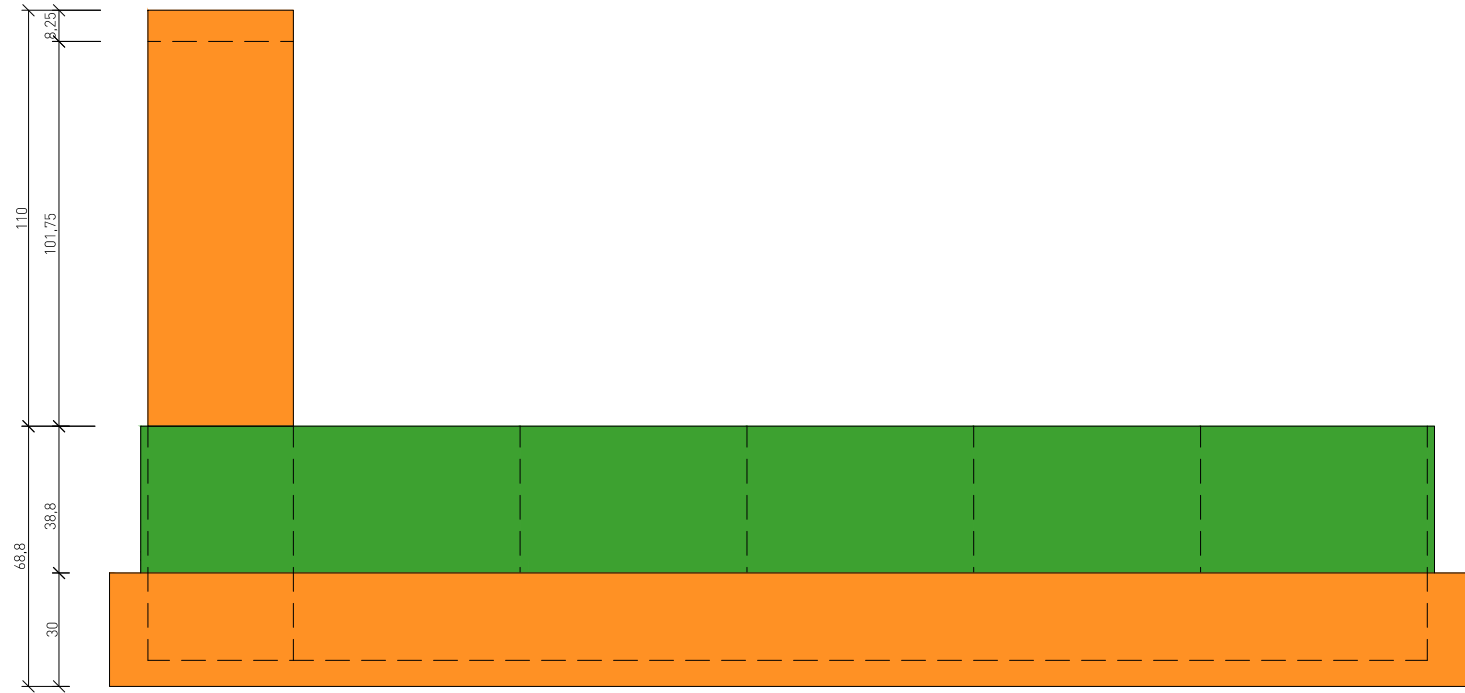

Profondeur: 23cm

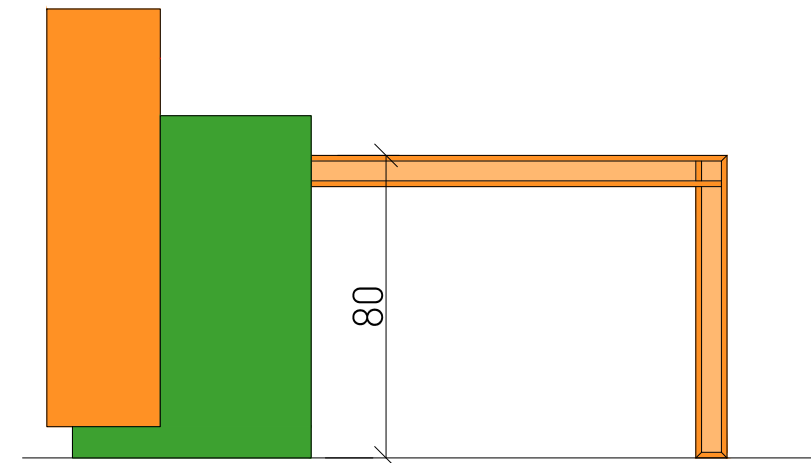
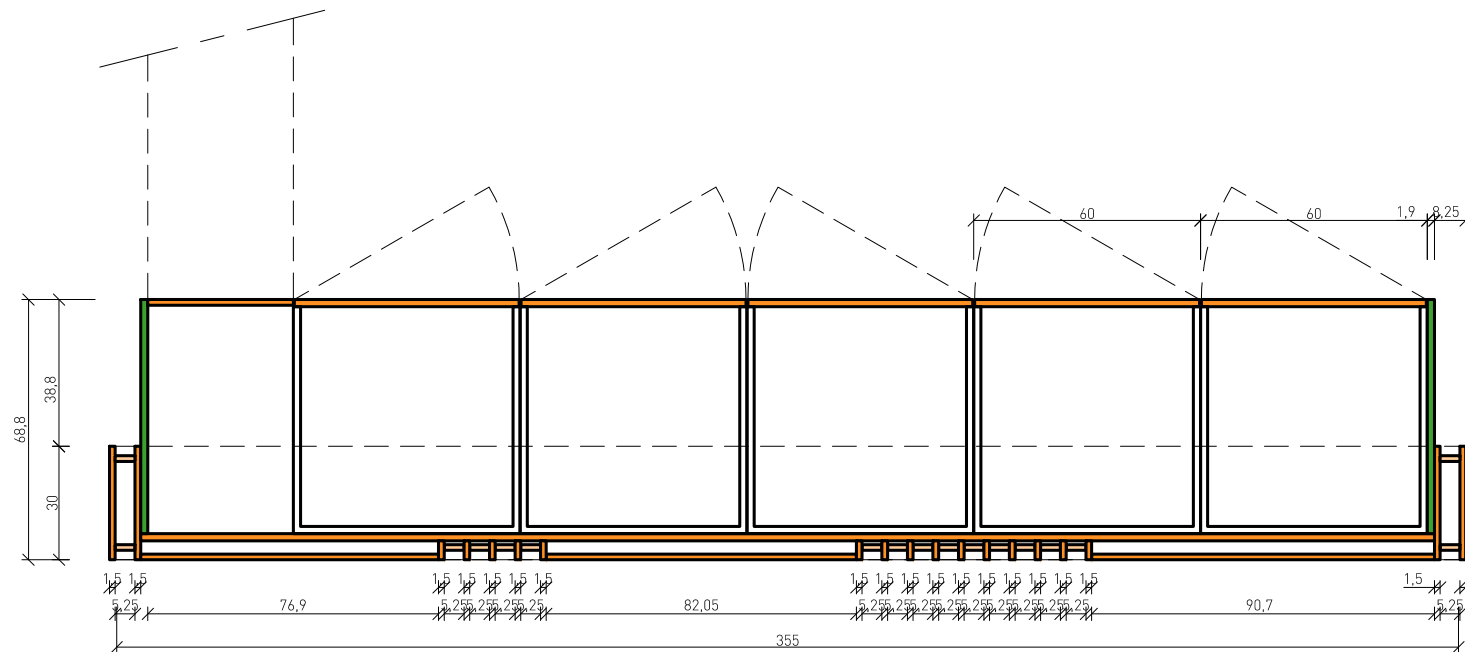
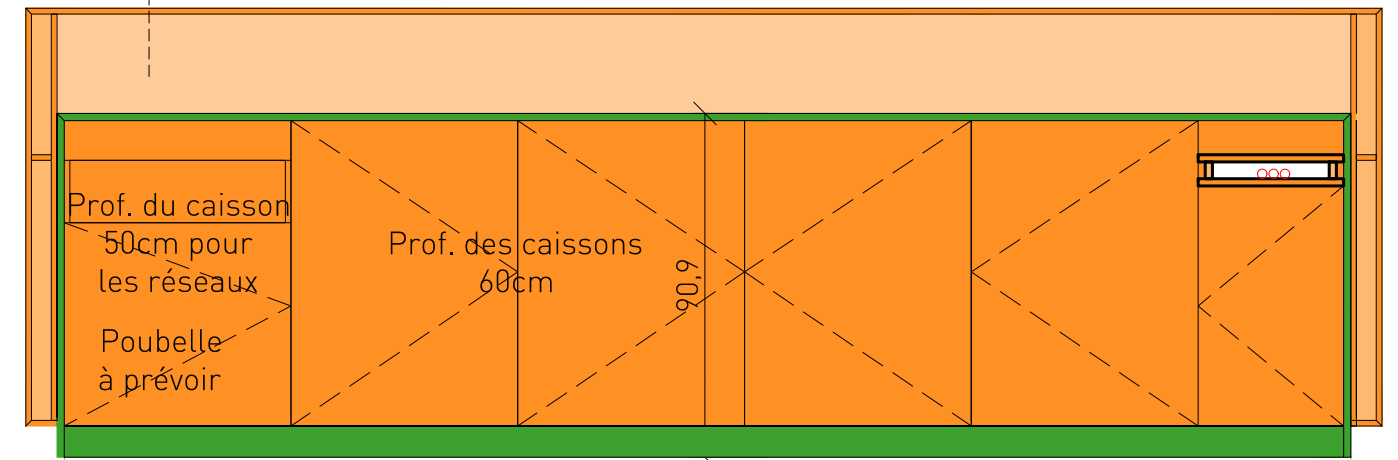

DC
daté du 30 Nov. 21
modifié le 05 Janv. 22
Page 12 /

ATOME
sarl d'architecture
Patrick Fiolleau
45bis rue Beaurepaire
49400 SAUMUR
SIRET 442 200 952 00053 - APE 7111Z
Ordre National des Architectes - S05212

Détail mobilier G1b I 1/20

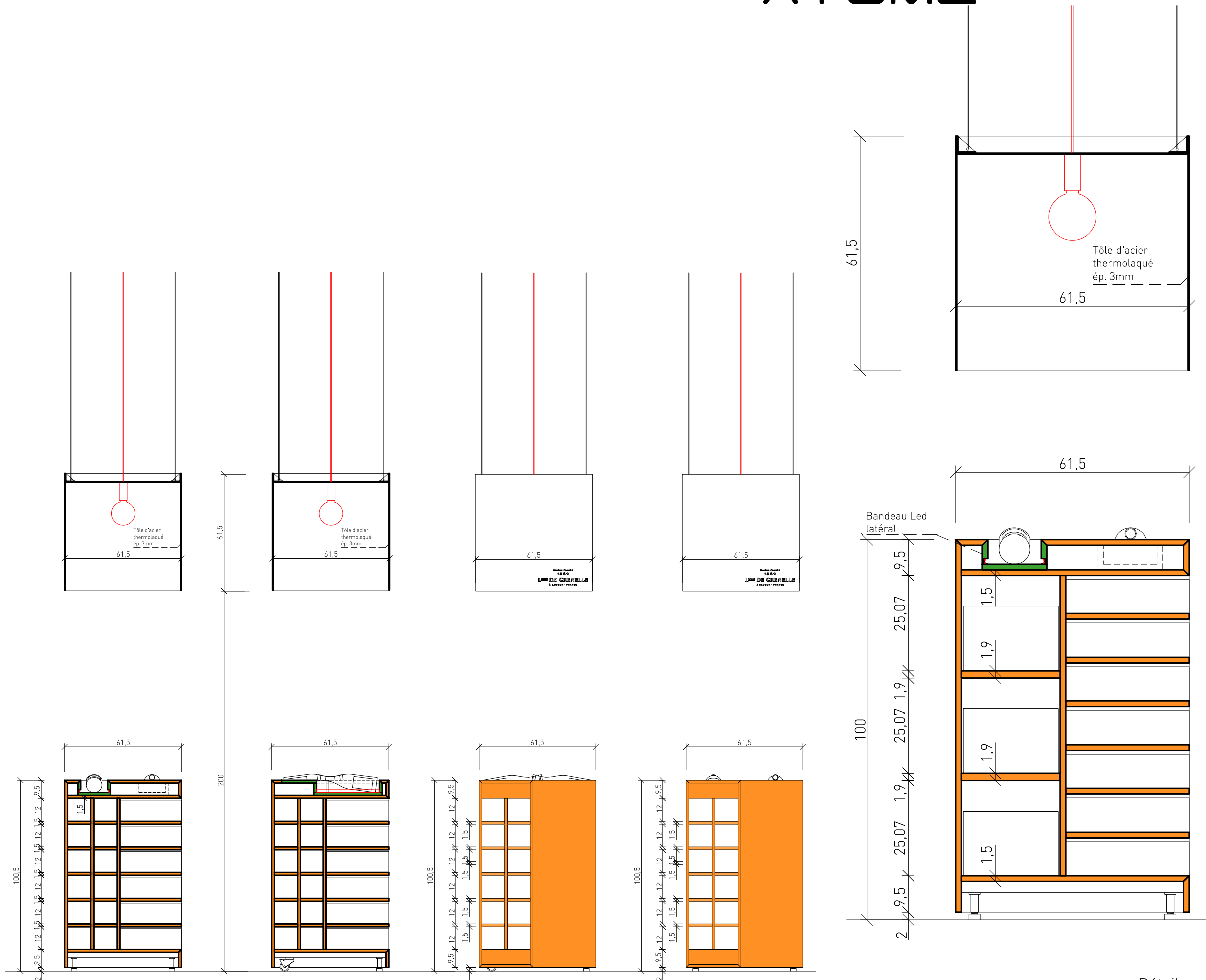

DC
 daté du 30 Nov. 20
 modifié le 05 Janv. 20
 Page 13 /

ATOME
 sarl d'architecture
 45bis rue Beaurepaire
 49400 SAUMUR
 SIRET 442 200 952 00053 - APE 7111Z
 Ordre National des Architectes - S05212

Détail mobilier de présentation I & J I 1/20 - 1/

Sarl d'Architecture
 Ordre National des Architectes S05212
 Siret 44220095200053 APE 71 11Z
 TVA intracommunautaire FR 22 442 200 952 00061
 www.atome-architectes.fr

Pays de la Loire
 Patrick FIOLEAU Architecte dplg
 45bis rue Beaurepaire 49400 SAUMUR
 02 41 52 61 69
 atome.saumur@architectes.org

Bretagne
 Arnaud METTELET Architecte dplg
 14 rue Toulbroch 56000 VANNES
 02 97 58 81 37
 atome.vannes@architectes.org

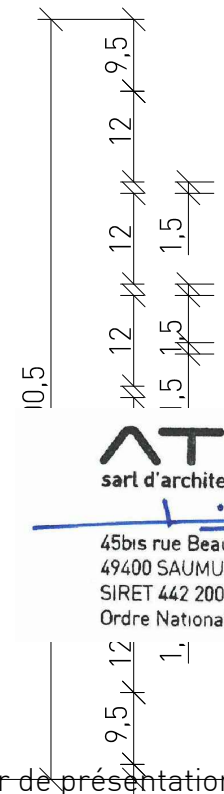
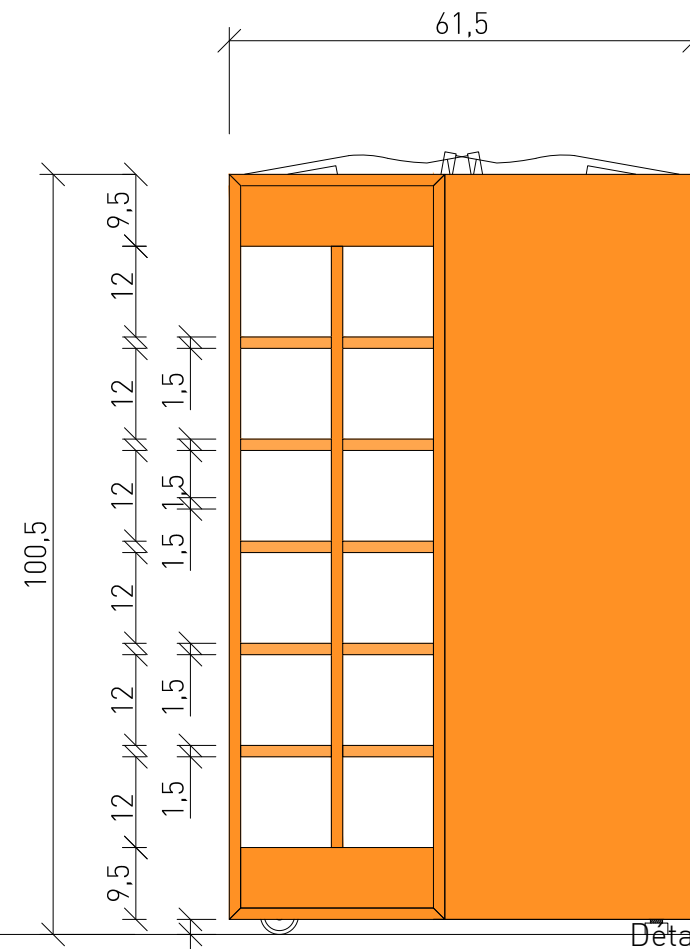
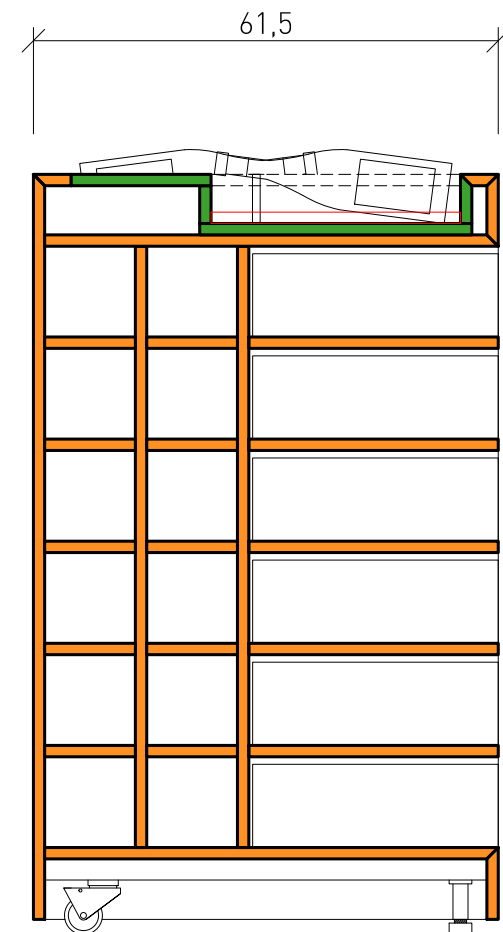
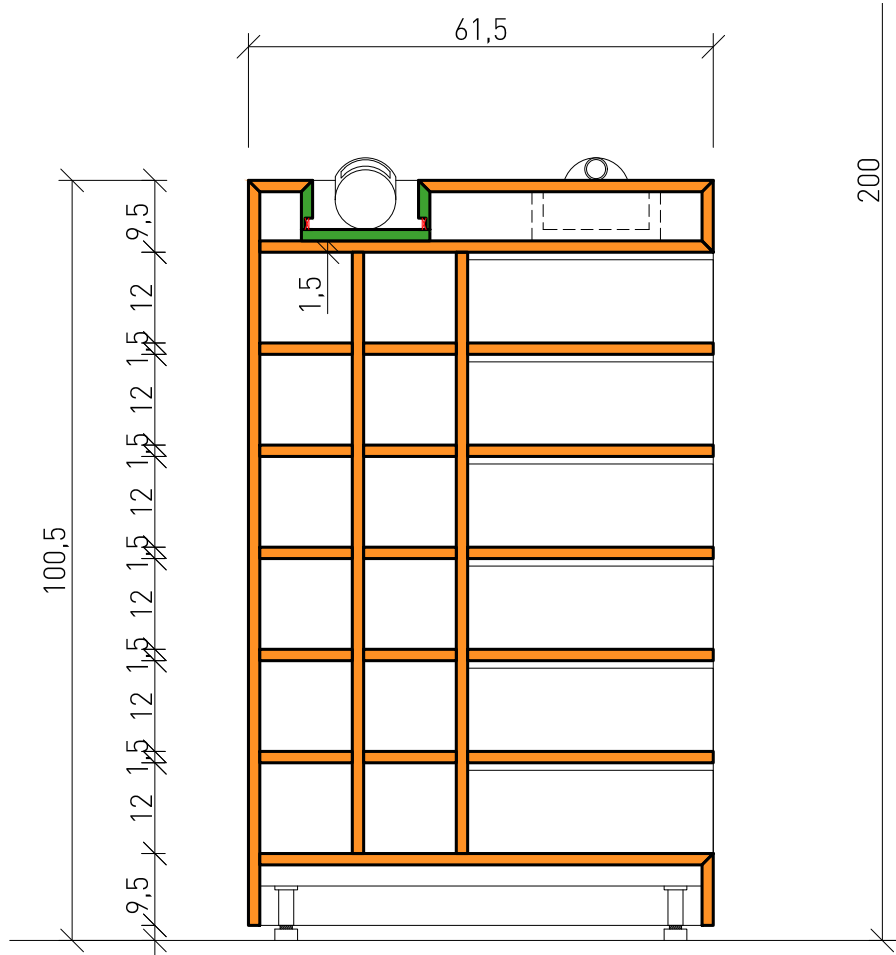
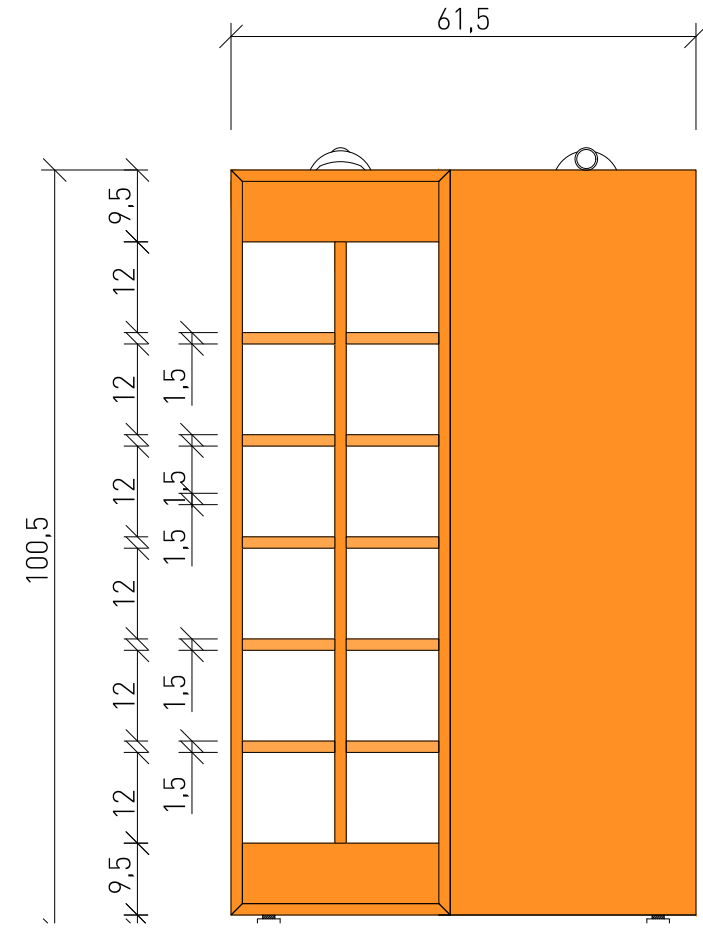
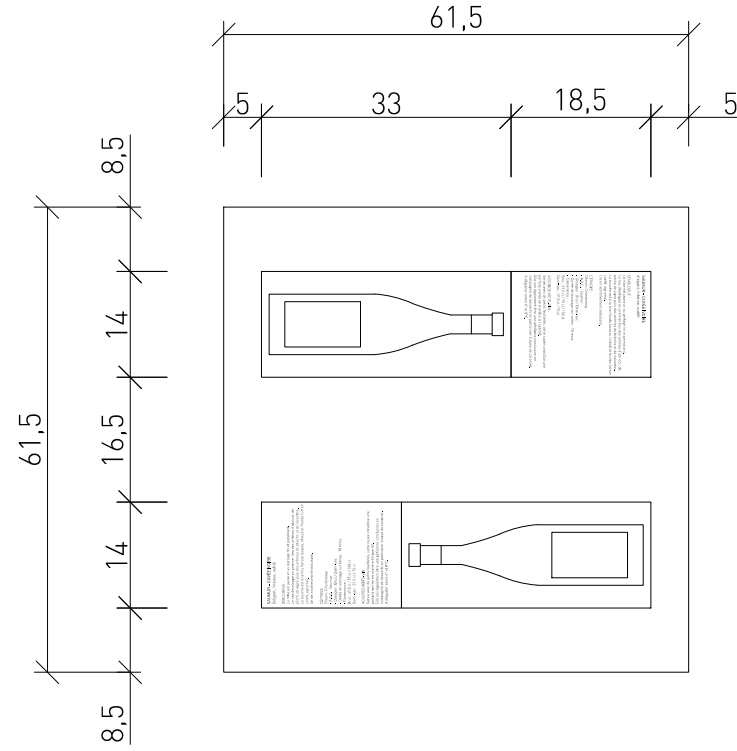
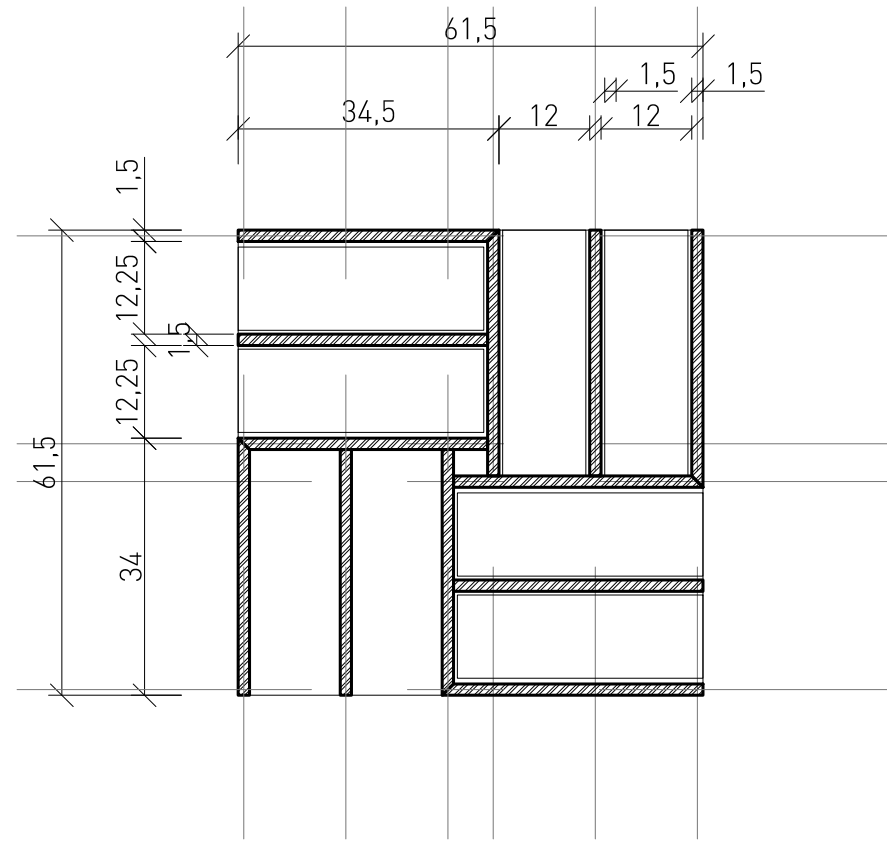

DC
daté du 30 Nov. 21
modifié le 05 Janv. 22
Page 14 /

ATOMÉ
sarl d'architecture

45bis rue Beaurepaire
49400 SAUMUR
SIRET 442 200 952 00053 - APE 7111Z
Ordre National des Architectes - S05212

Détail mobilier de présentation II 1/10

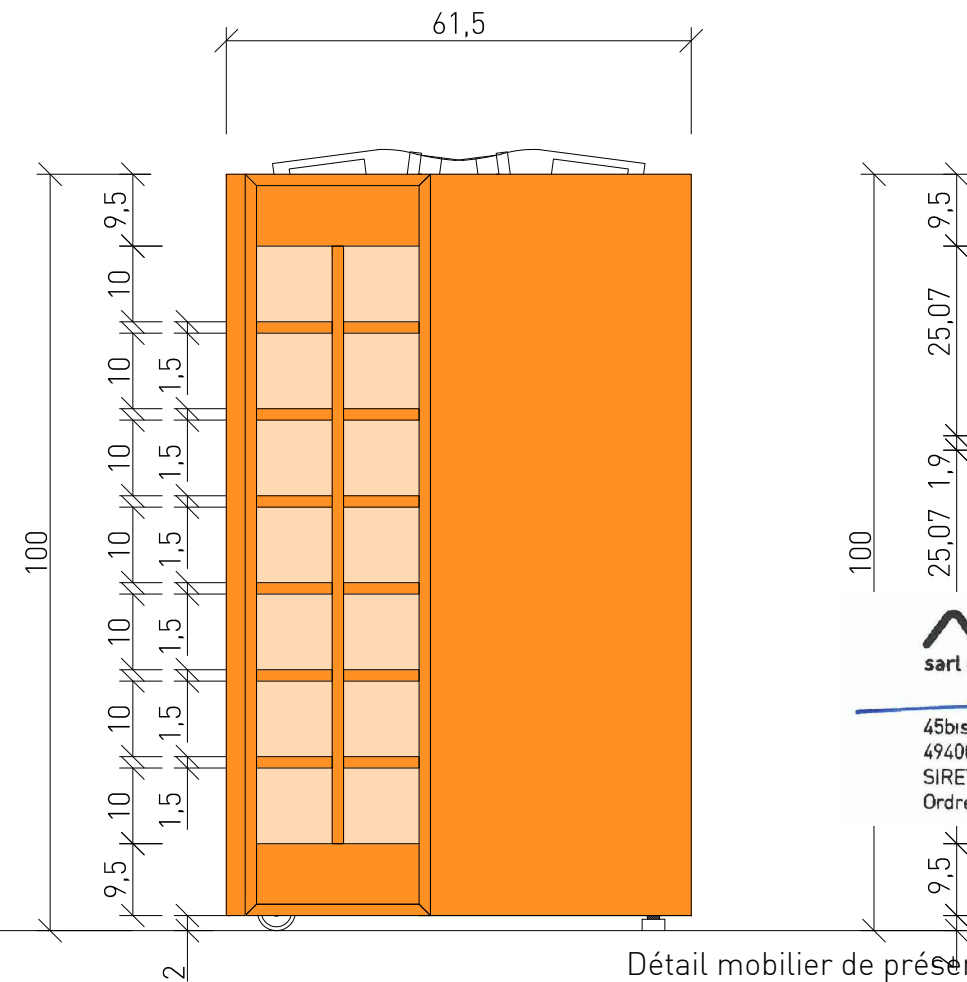
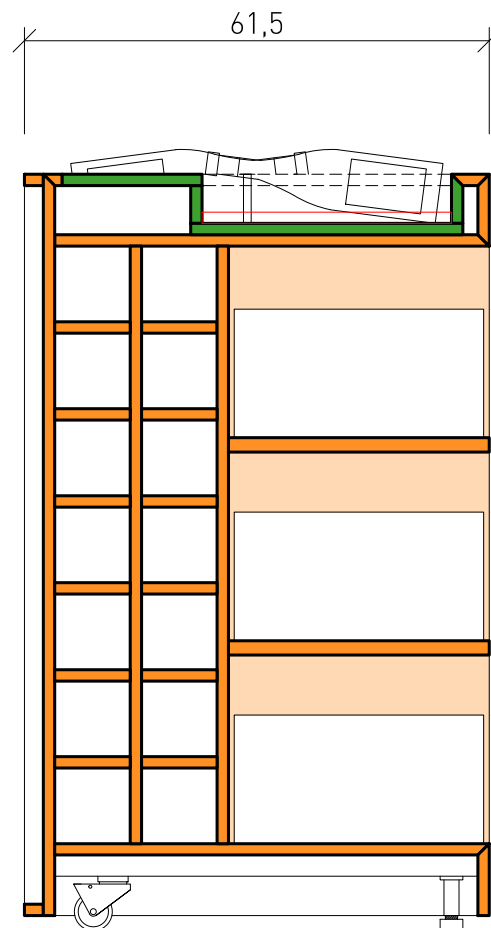
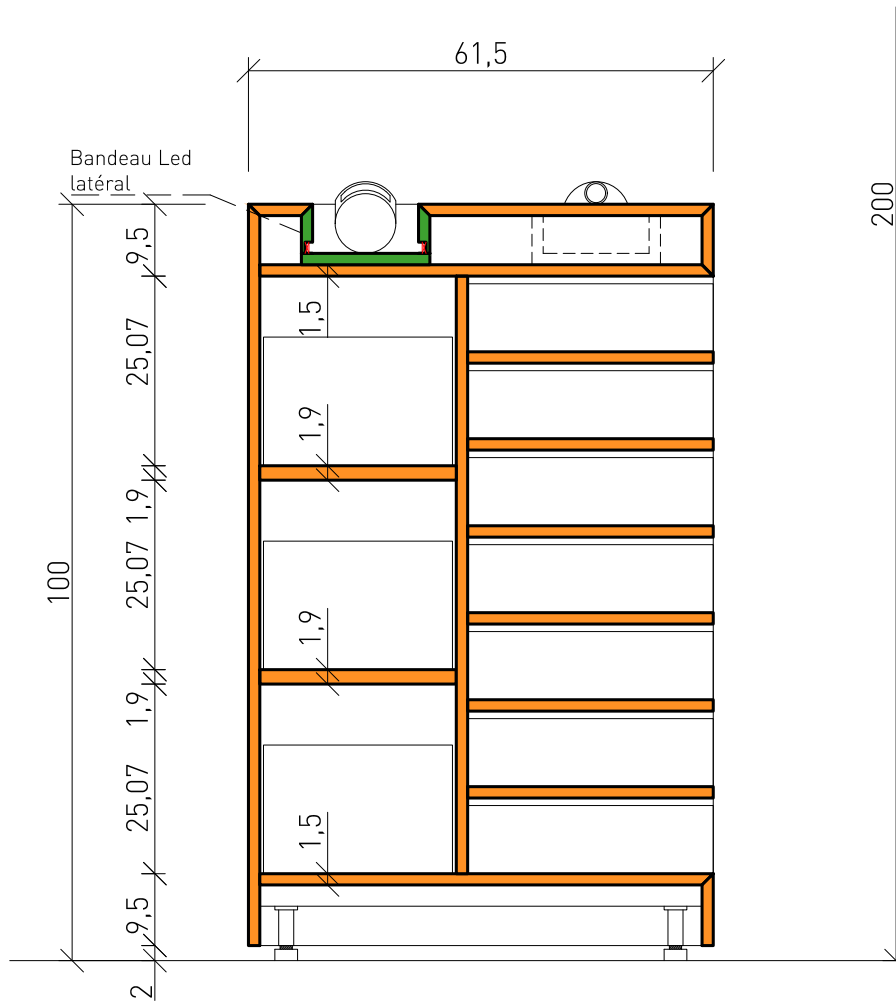
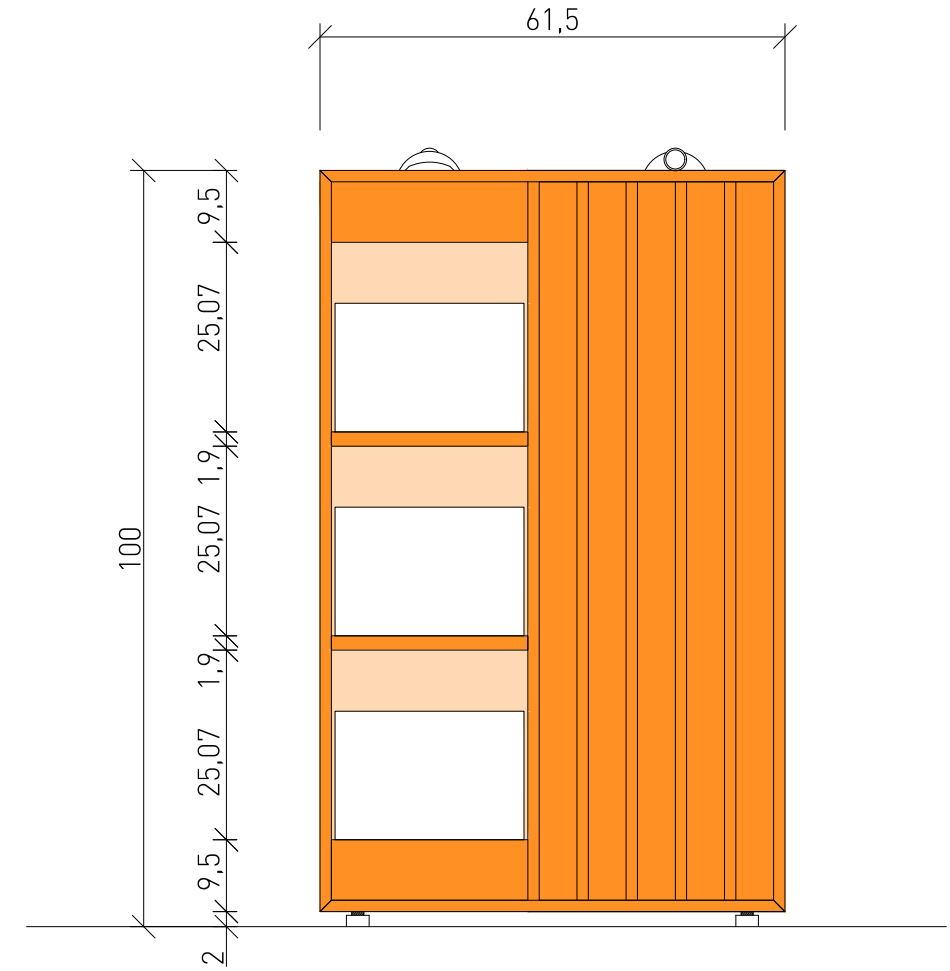
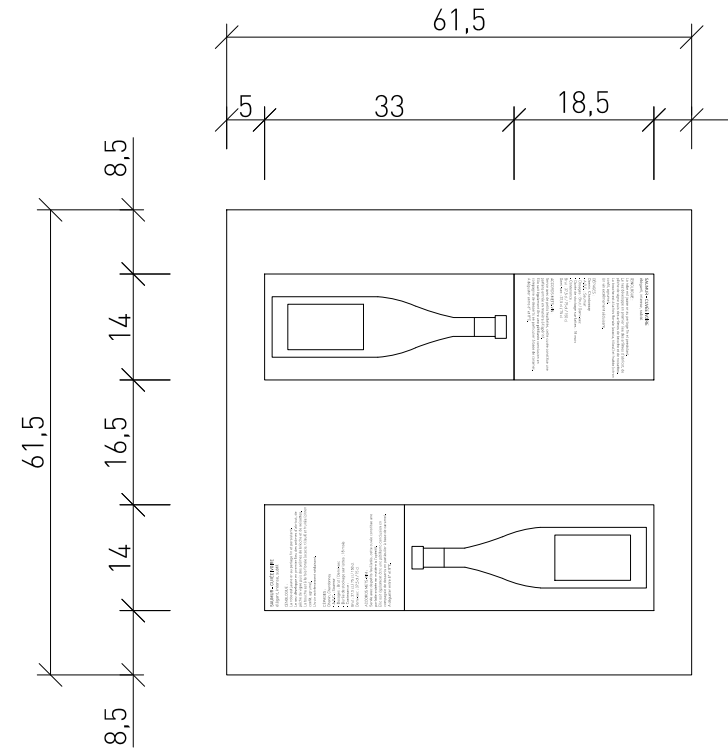
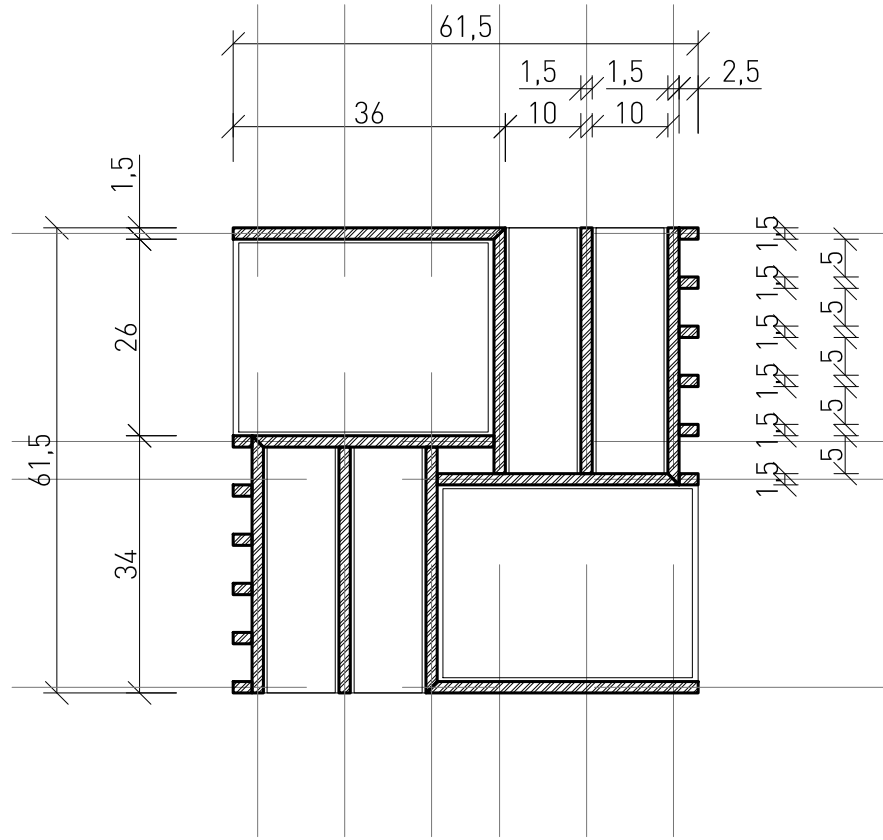

DC
daté du 30 Nov. 21
modifié le 05 Janv. 22
Page 15 /

ATOME
sarl d'architecture
45bis rue Beaurepaire
49400 SAUMUR
SIRET 442 200 952 00053 - APE 7111Z
Ordre National des Architectes - S05212

Détail mobilier de présentation J I 1/10