

AXONOMETRIE 1

Maison locale d'activité

Saint Maur des Fossés

Echelle :

Date: 18/06/15

PLAN N°: - FEUILLE - Indice

2

- 01 -

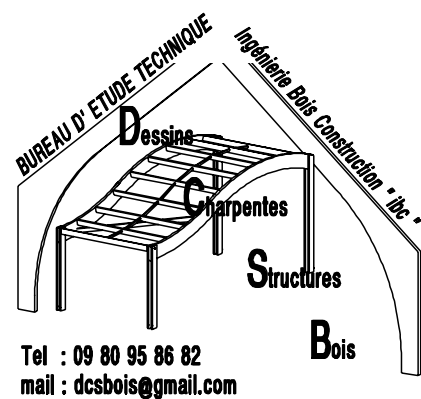
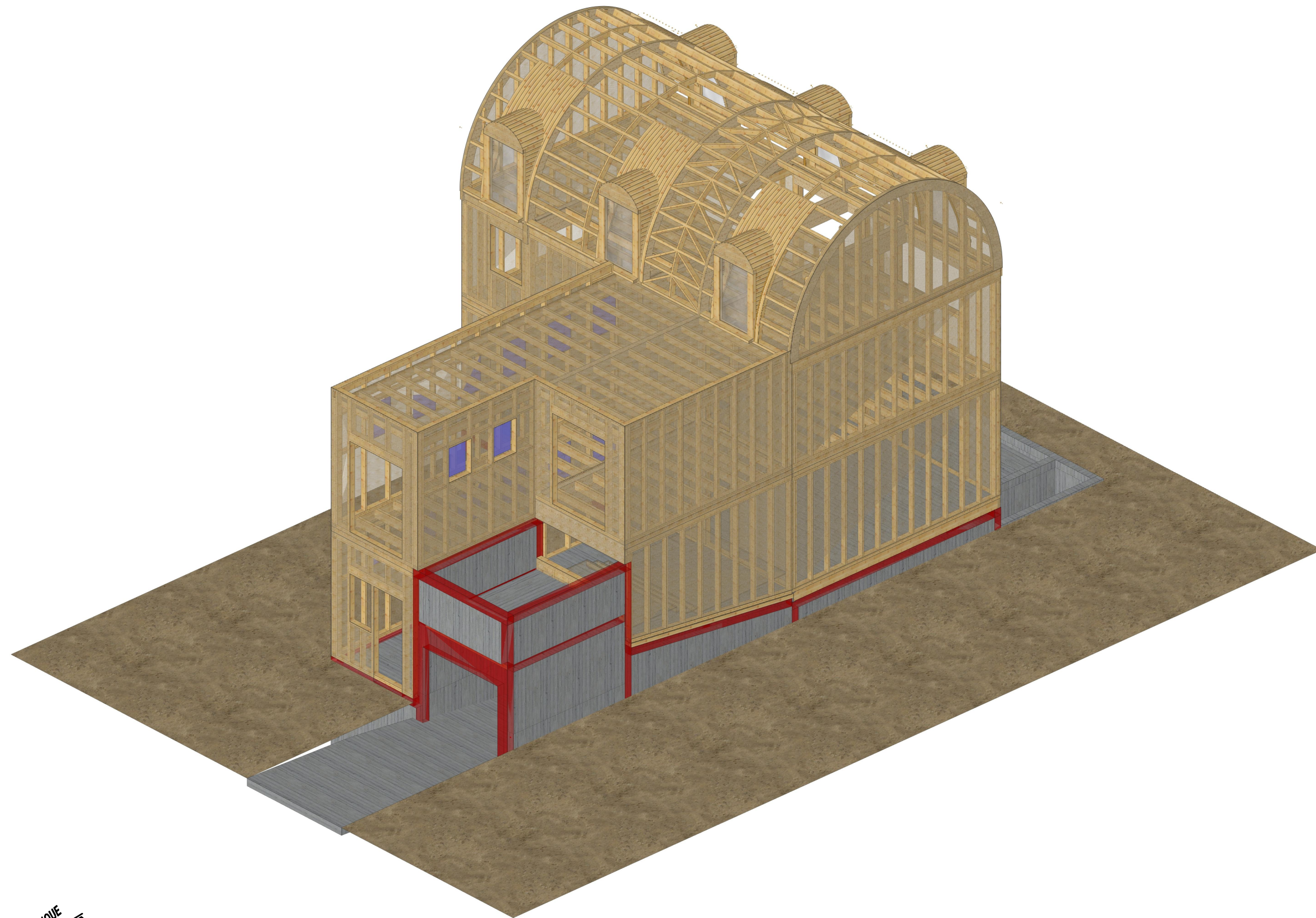

AXONOMETRIE 2

Maison locale d'activité

Saint Maur des Fossés

Echelle :

Date: 18/06/15

PLAN N°: - FEUILLE - Indice

2 - 02 -

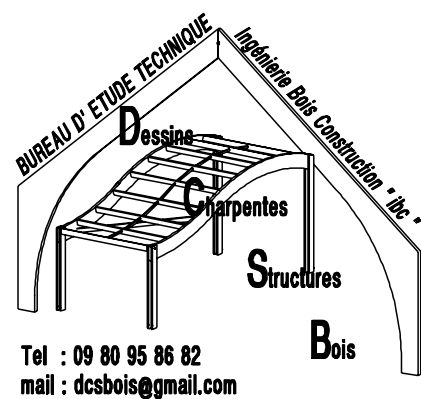
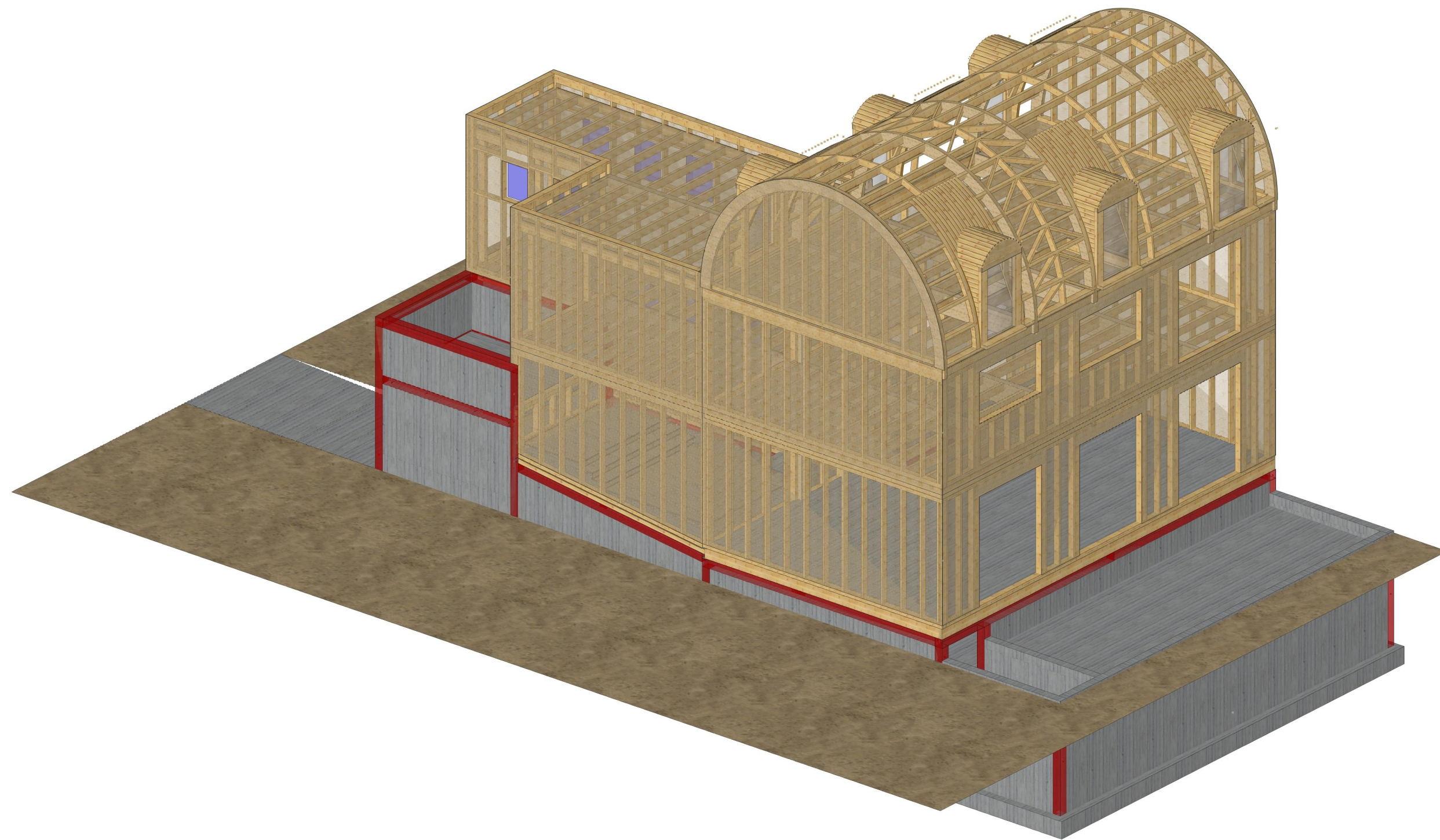

AXONOMETRIE 3

Maison locale d'activité

Saint Maur des Fossés

Echelle :

Date: 18/06/15

PLAN N°: - FEUILLE - Indice

2

- 03 -

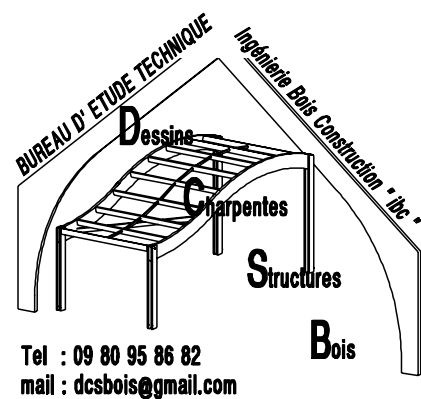
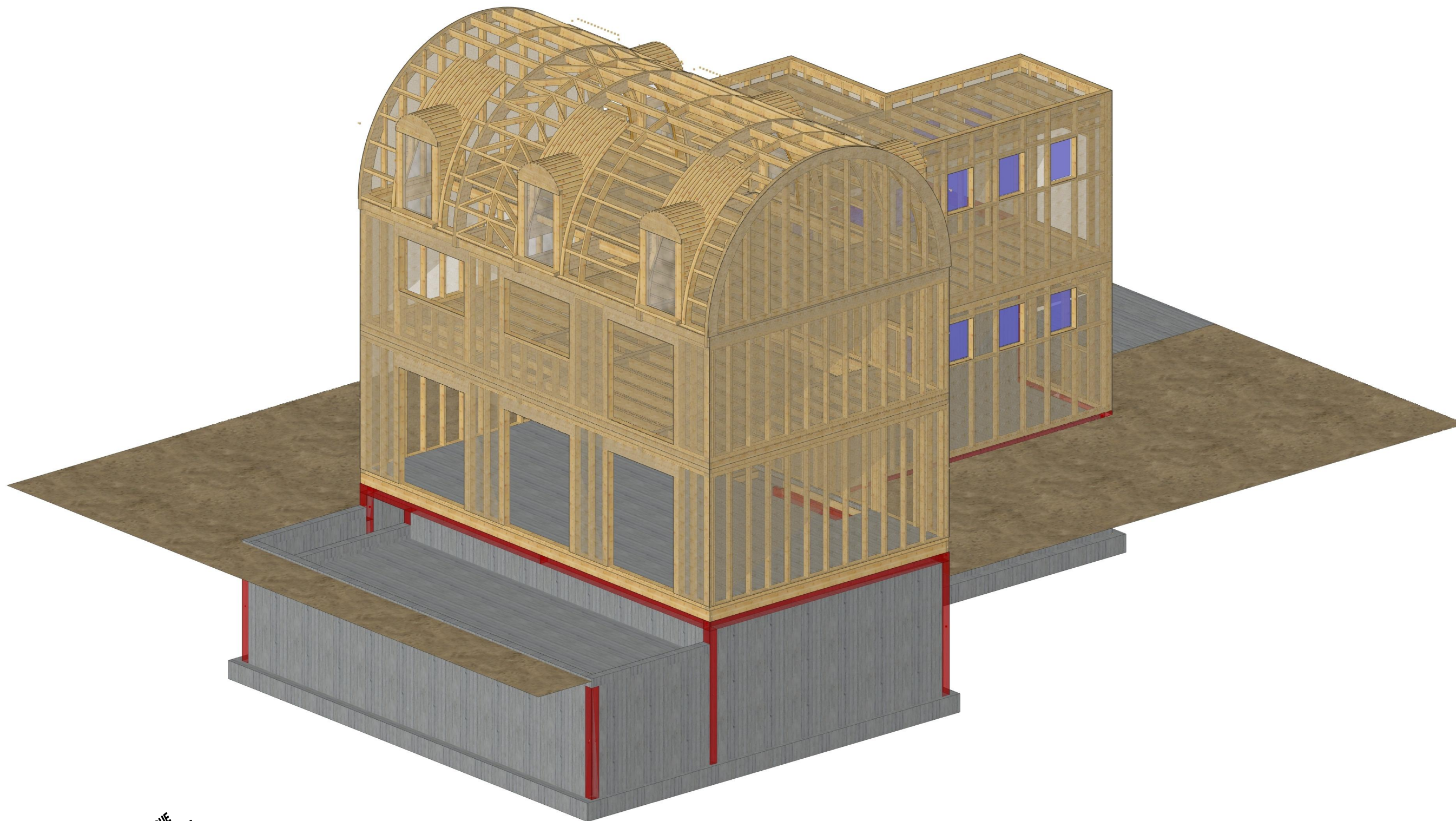

AXONOMETRIE 4

Maison locale d'activité

Saint Maur des Fossés

Echelle :

Date: 18/06/15

PLAN N°: - FEUILLE - Indice

2

- 04 -

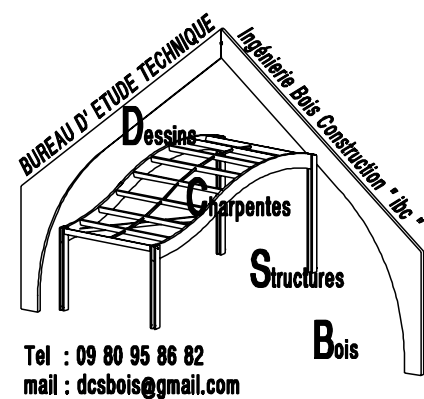
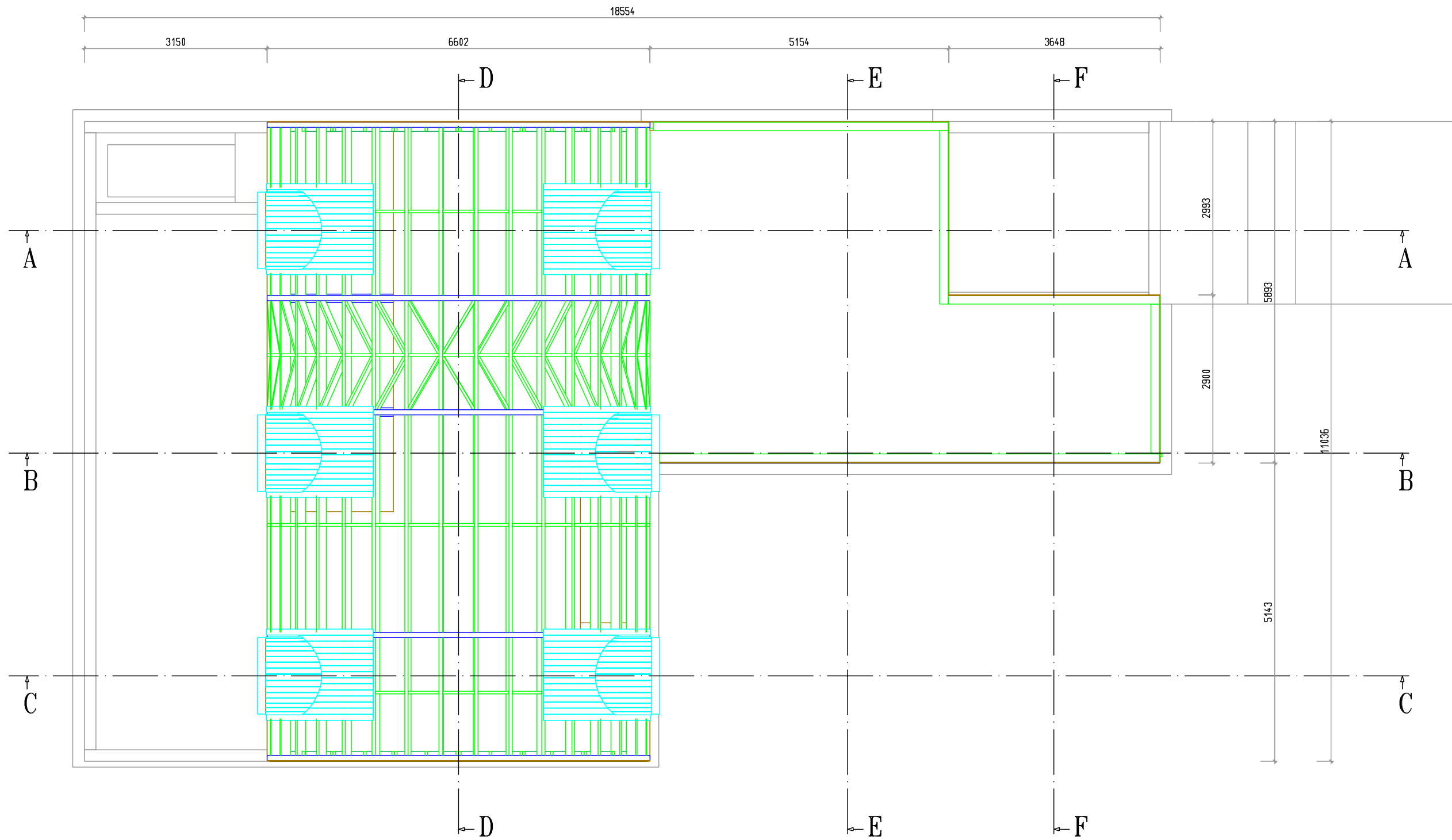

Maison locale d'activité

Saint Maur des Fossés

Echelle :

Date: 18/06/15

PLAN N°: - FEUILLE - Indice

2 - 05 -

VUE en PLAN

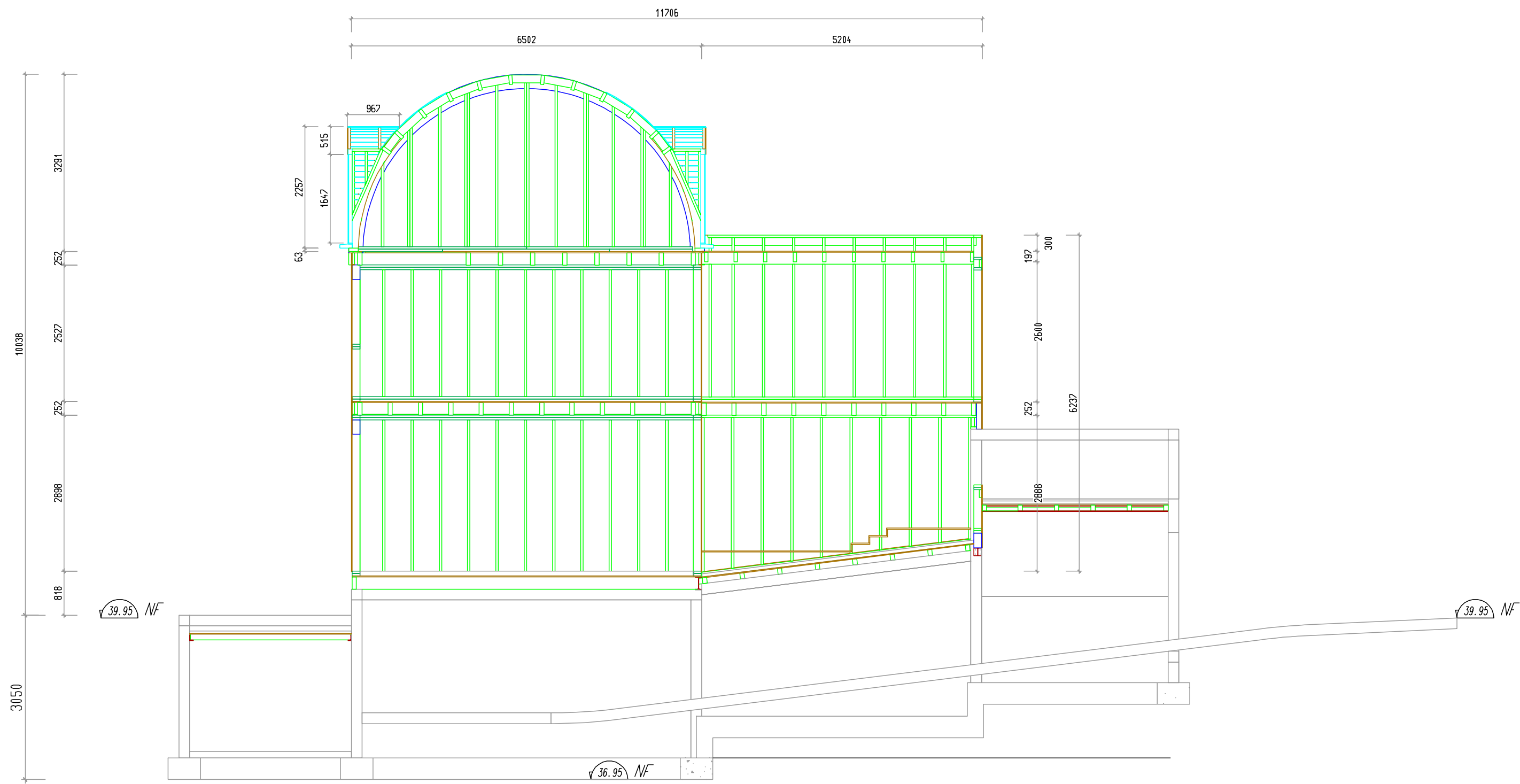

COUPE A-A

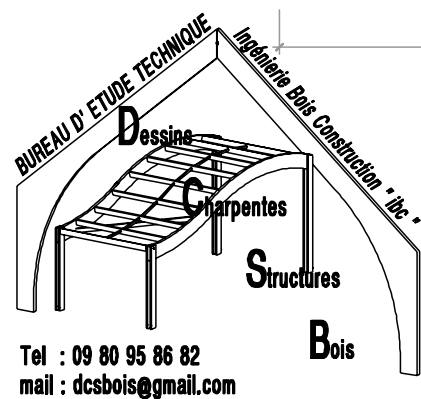

Maison locale d'activité

Saint Maur des Fossés

Echelle :

Date: 18/06/15

PLAN N°: - FEUILLE - Indice

2 - 06 -

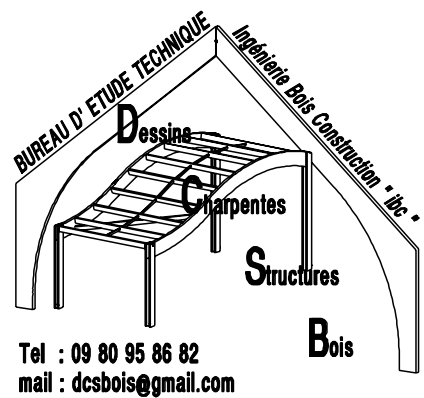
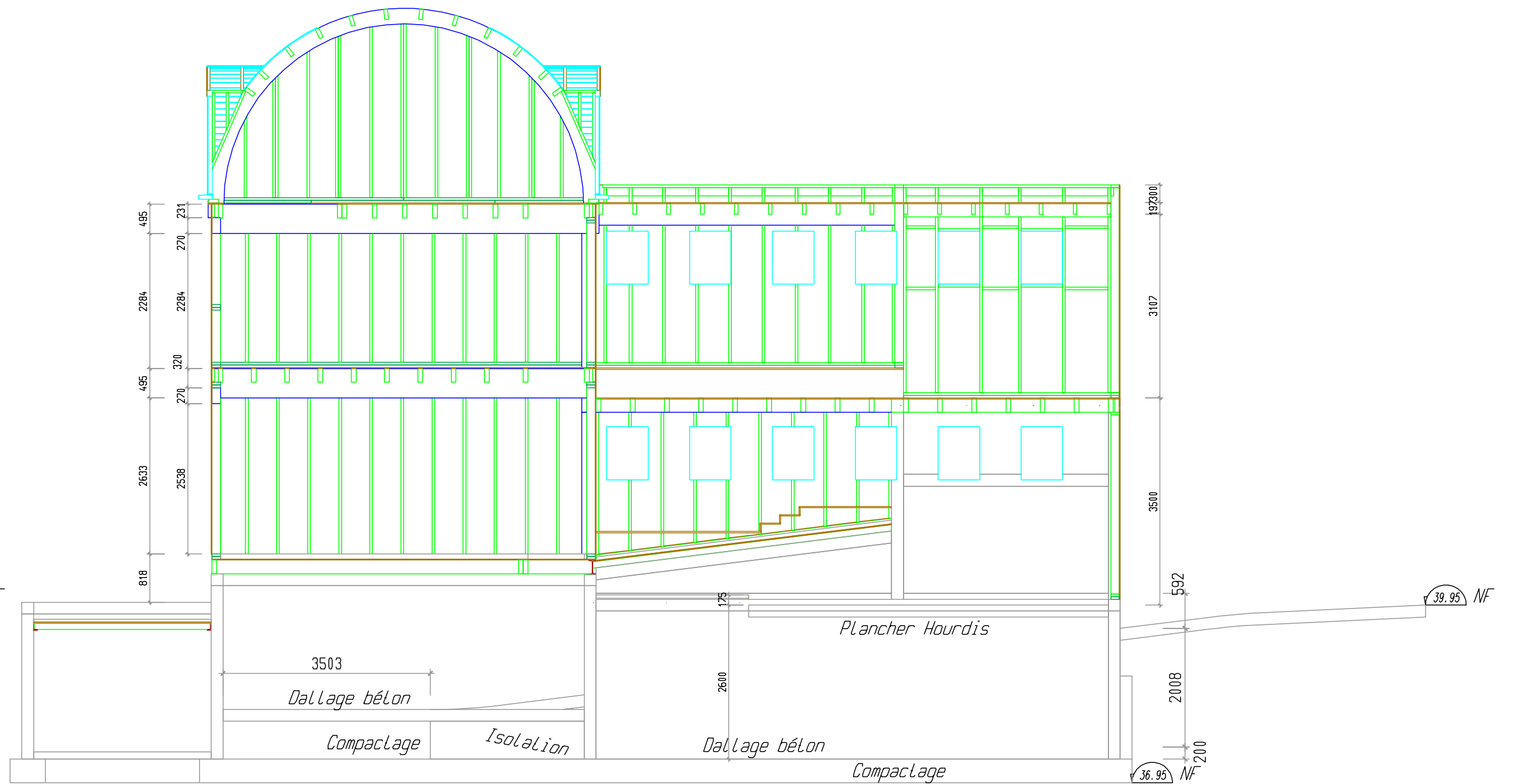

COUPE B-B

Maison locale d'activité

Saint Maur des Fossés

Echelle :

Date: 18/06/15

PLAN N°: - FEUILLE - Indice

2 - 07 -

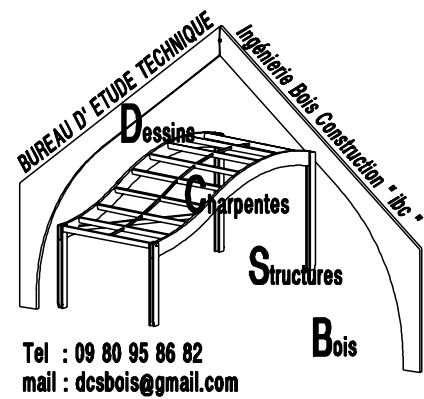
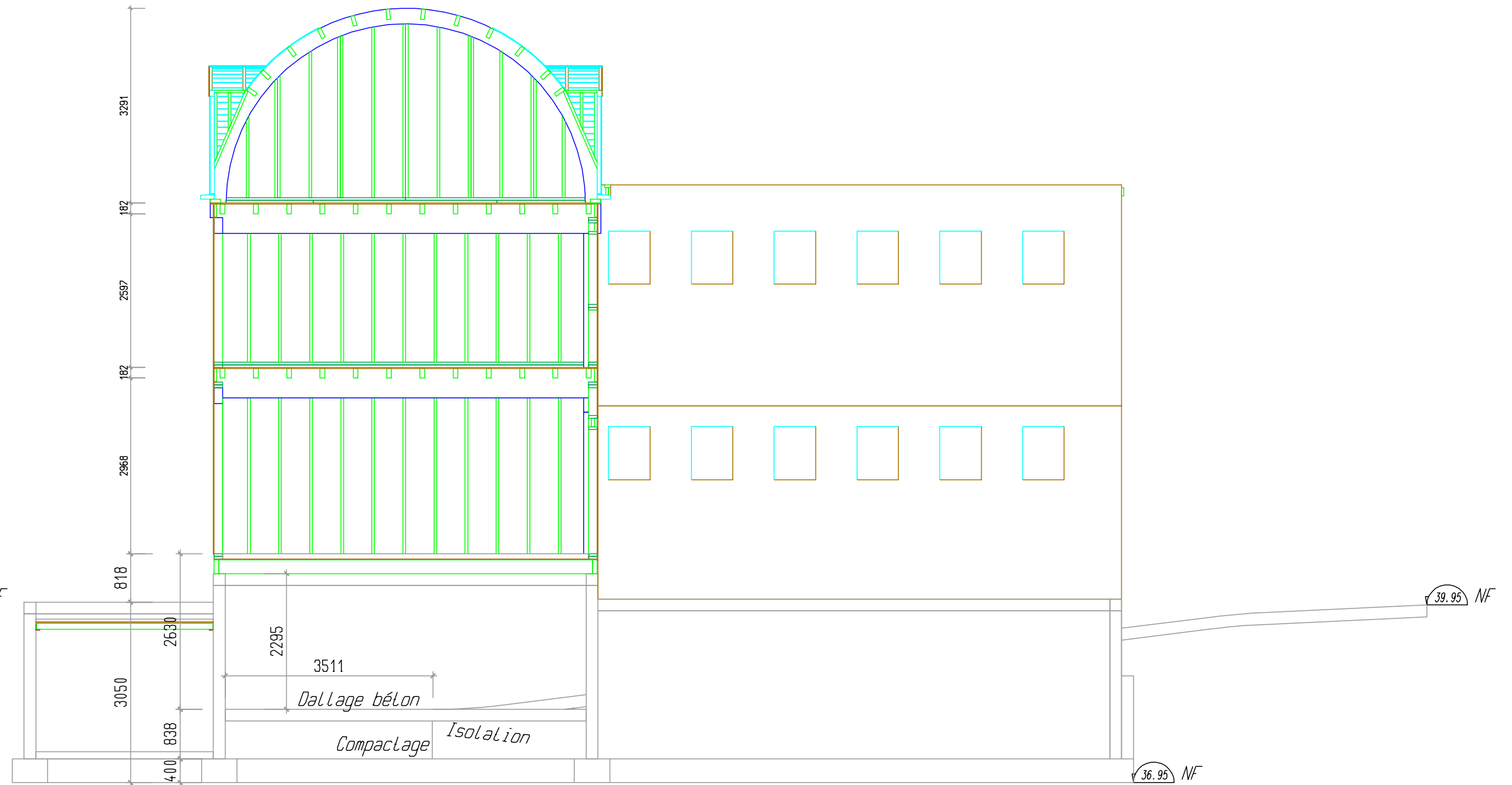

COUPE C-C

Maison locale d'activité

Saint Maur des Fossés

Echelle :

Date: 18/06/15

PLAN N°: - FEUILLE - Indice

2 - 08 -

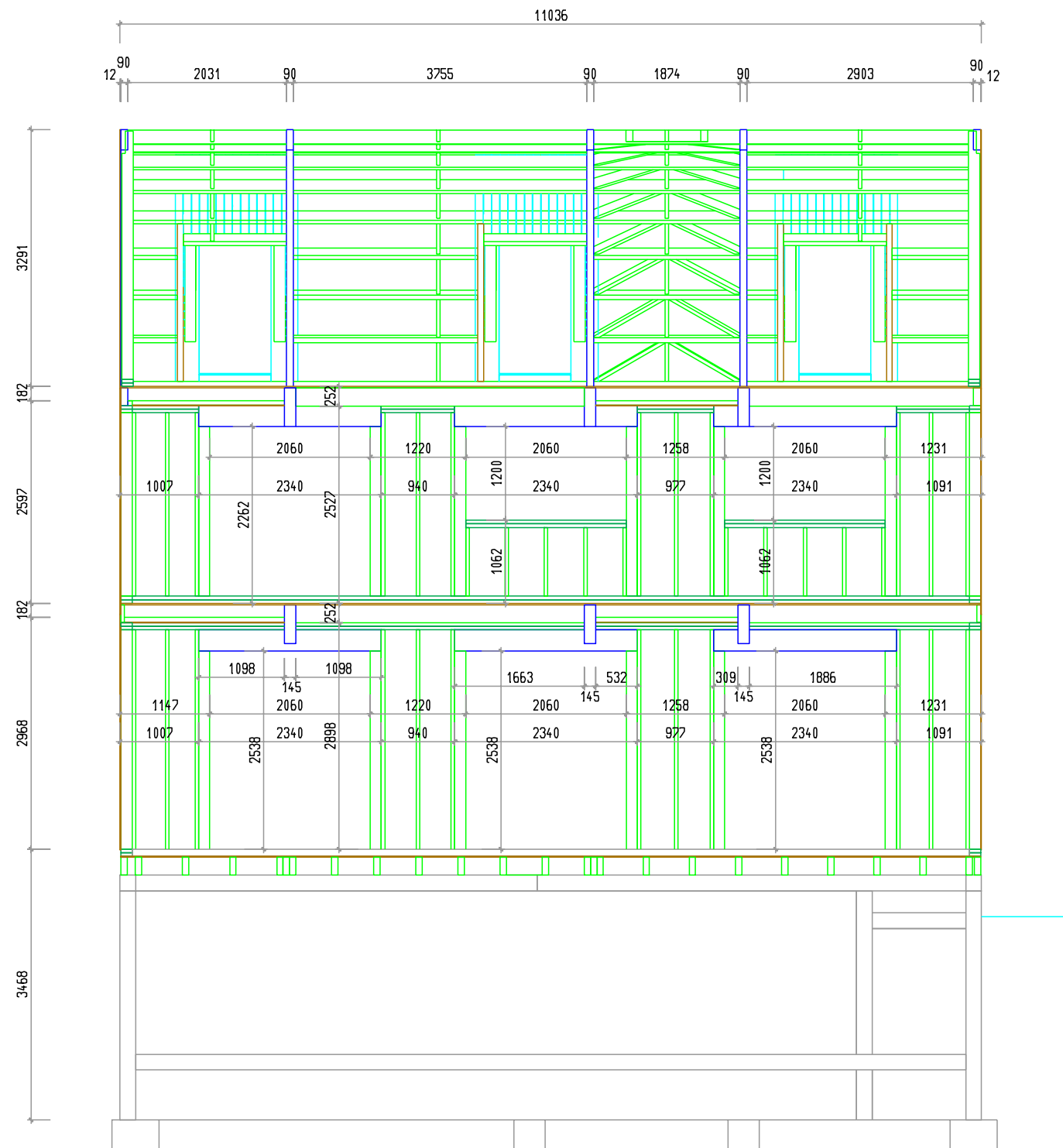

COUPE D-D

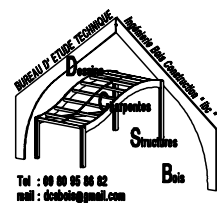

Maison locale d'activité

Saint-Maur des Fossés

Echelle :

Date: 18/06/15

PLAN N°: - FEUILLE - Indice

2 - 09 -

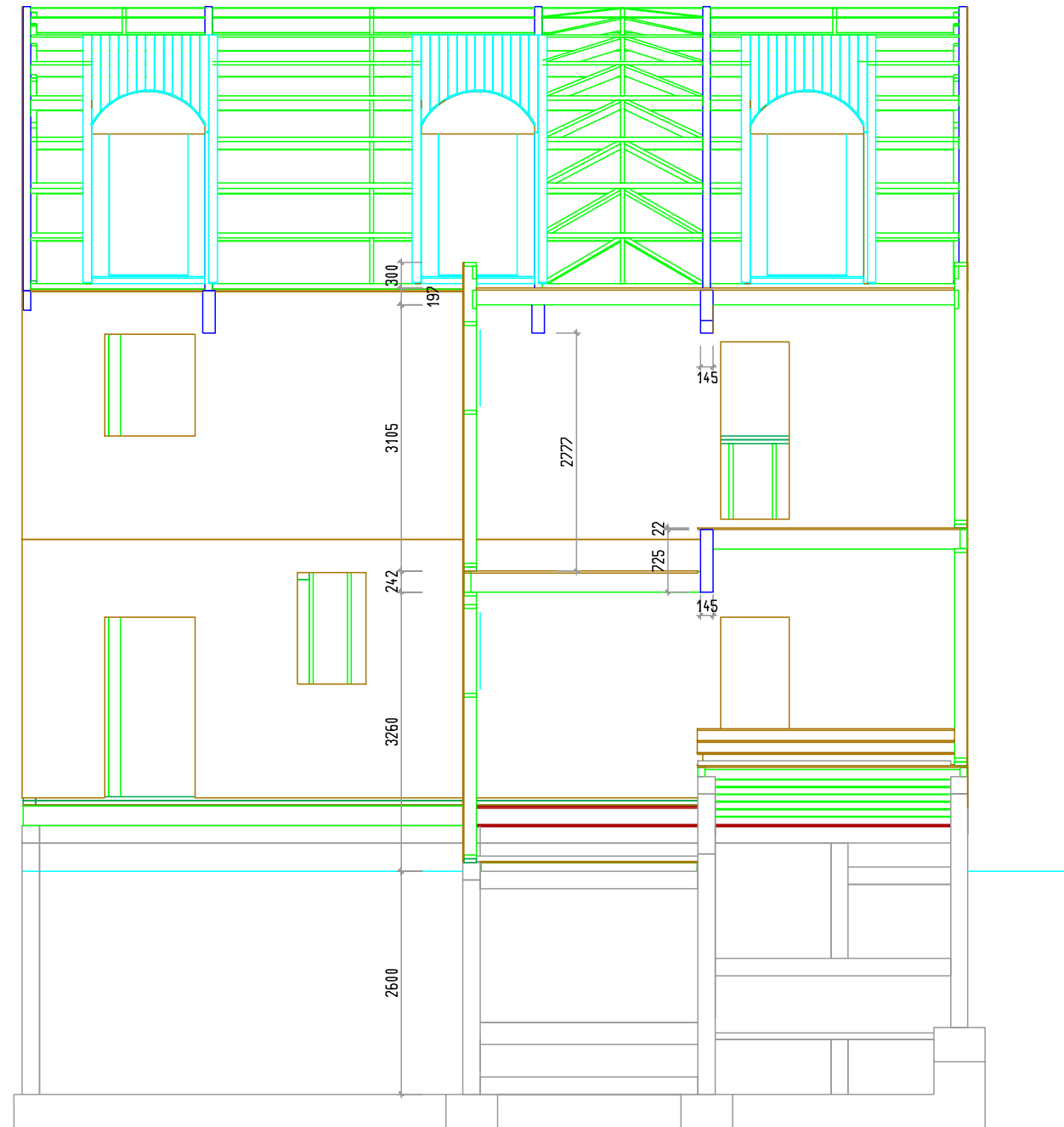

COUPE E-E

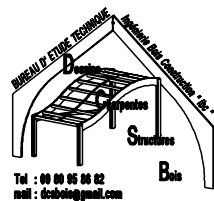

Maison locale d'activité

Saint Maur des Fossés

Echelle :

Date: 18/06/15

PLAN N°: - FEUILLE - Indice

2 - 10 -

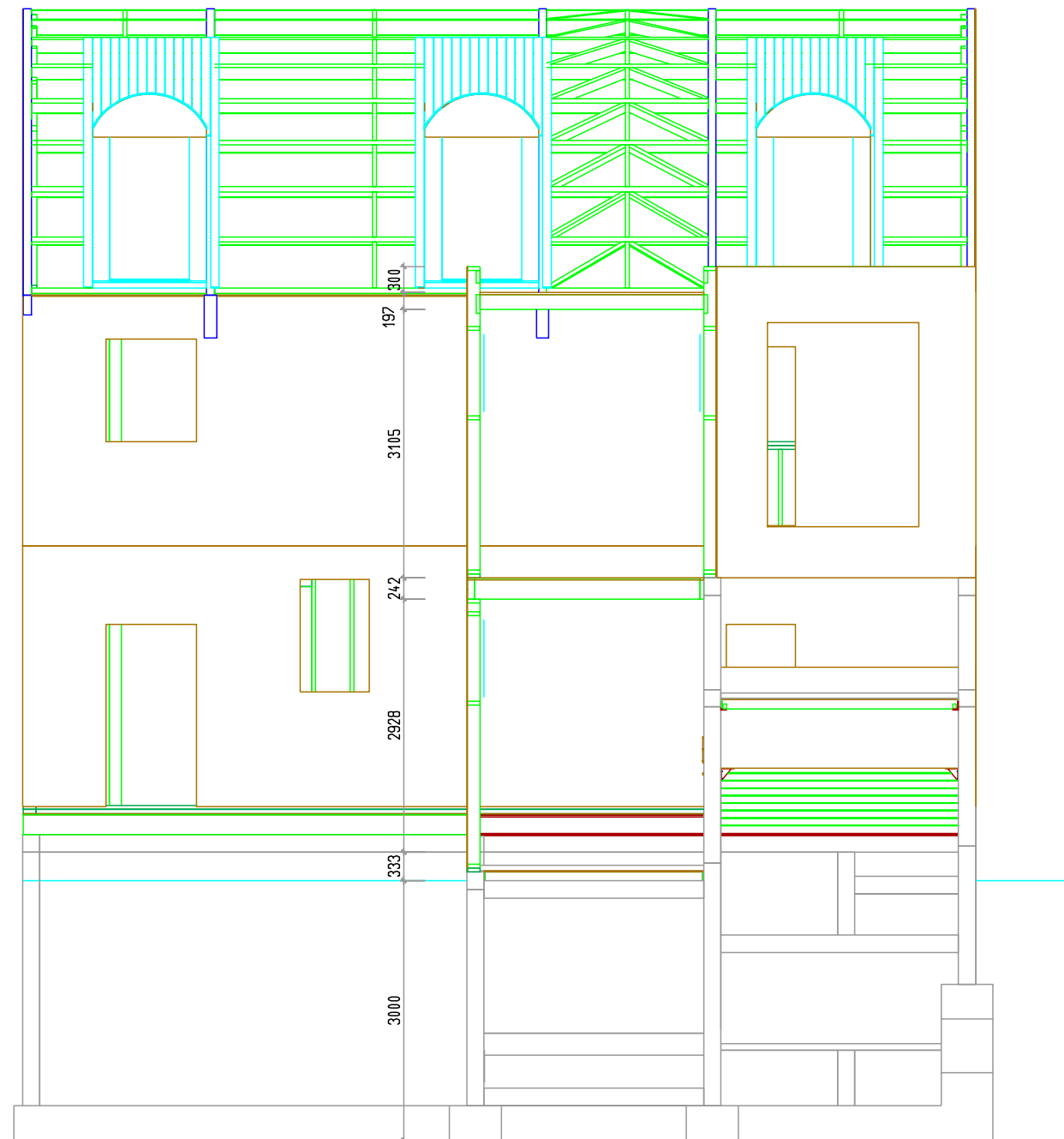

COUPE F-F

Maison locale d'activité

Saint Maur des Fossés

Echelle :

Date: 18/06/15

PLAN N°: - FEUILLE - Indice

2 - 11 -

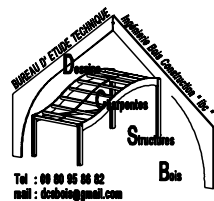

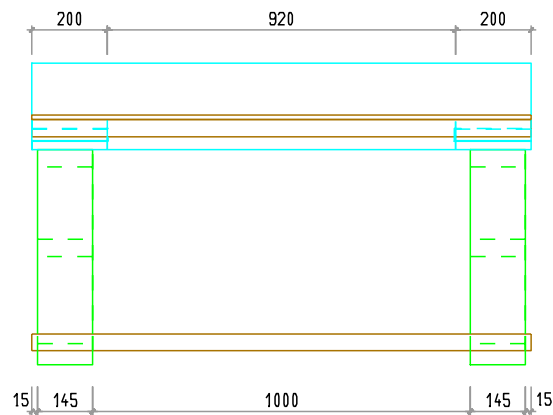
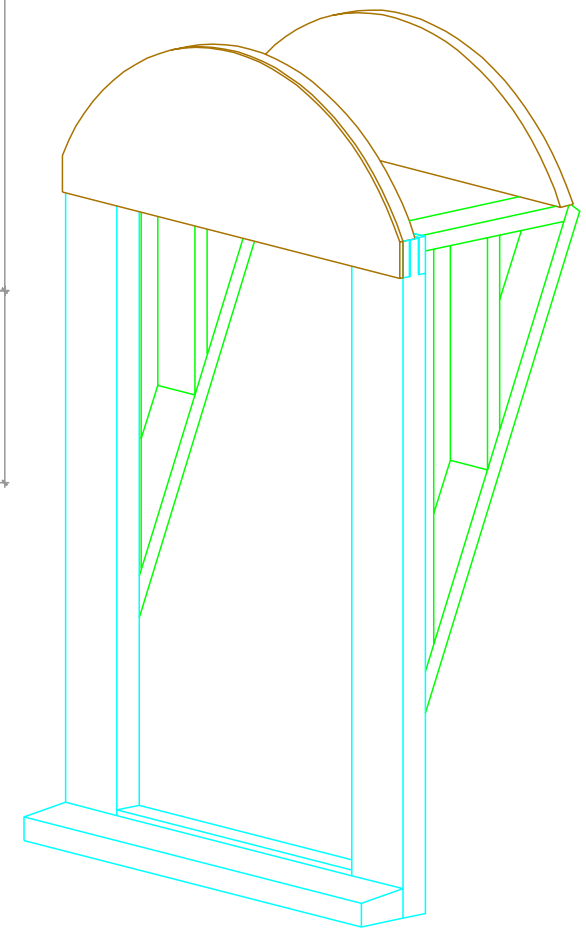
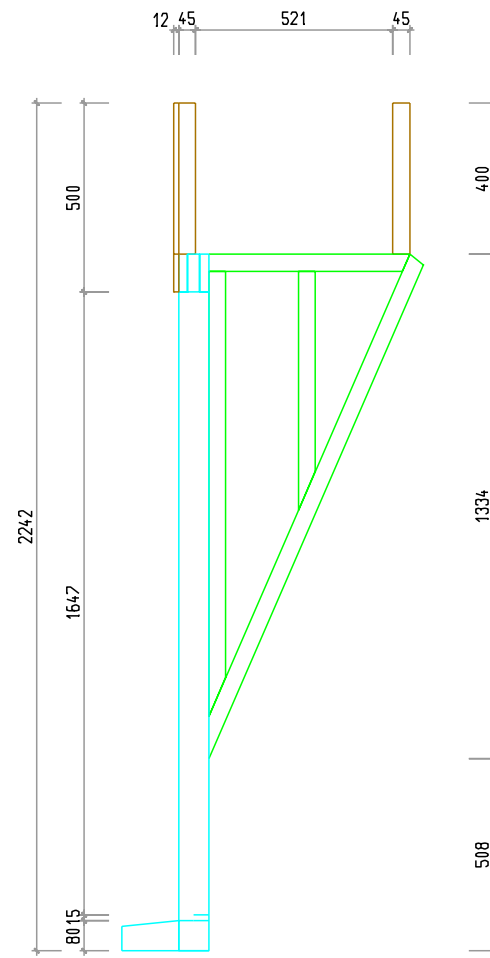
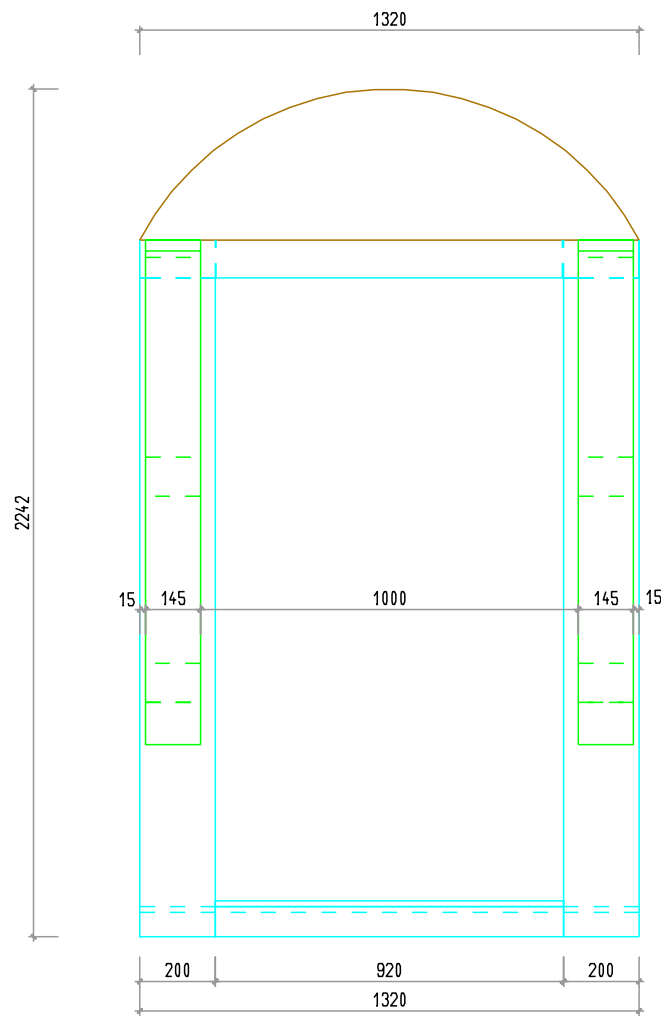
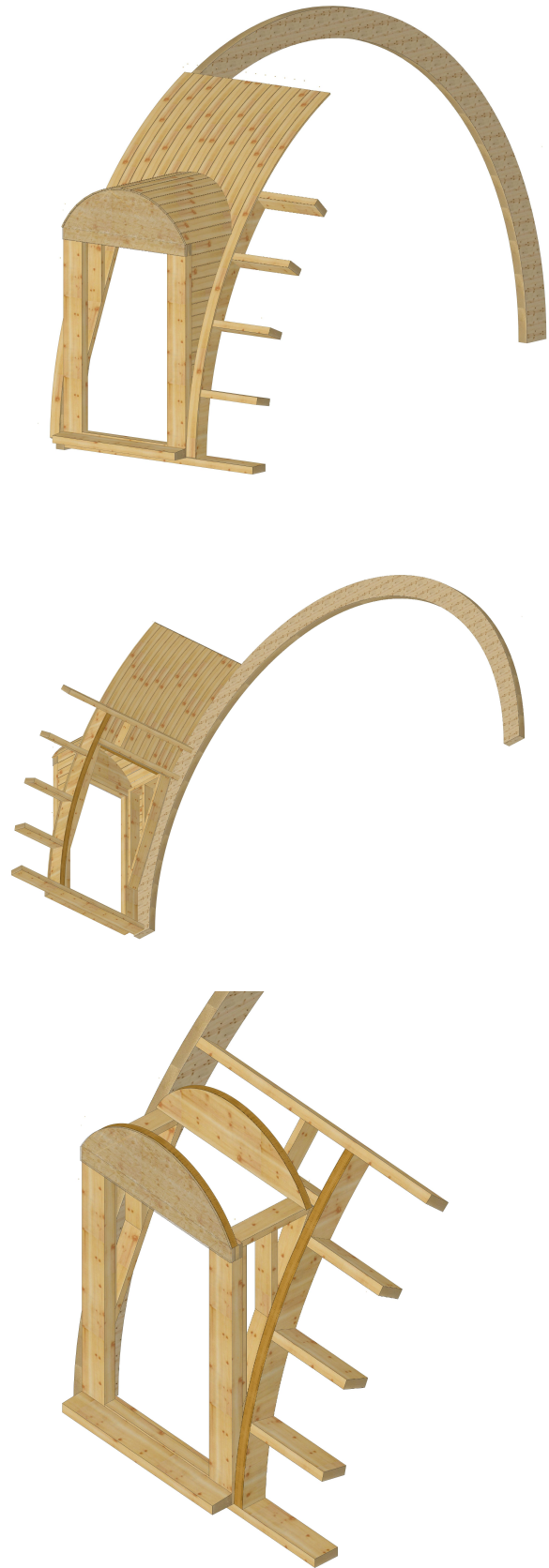

LUCARNES

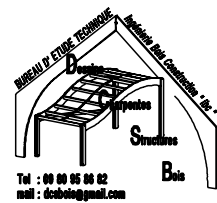

Maison locale d'activité

Saint-Maur des Fossés

Echelle :

Date: 18/06/15

PLAN N°: - FEUILLE - Indice

2 - 12 -

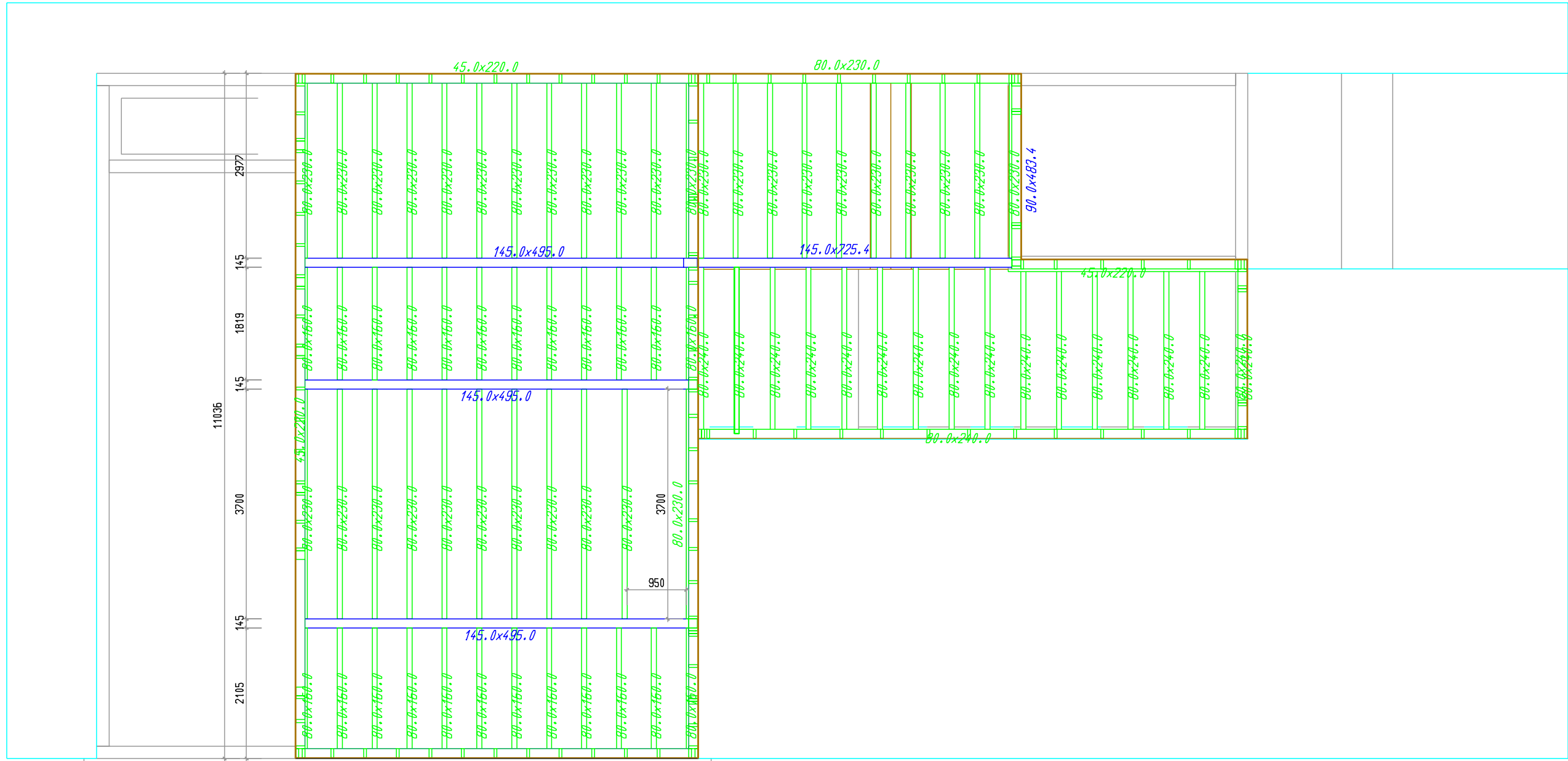

PLANCHER R+1

Maison locale d'activité

Saint Maur des Fossés

Echelle :

Date: 18/06/15

PLAN N°: - FEUILLE - Indice

2 - 13 -

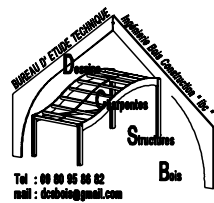

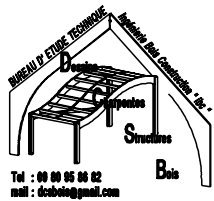
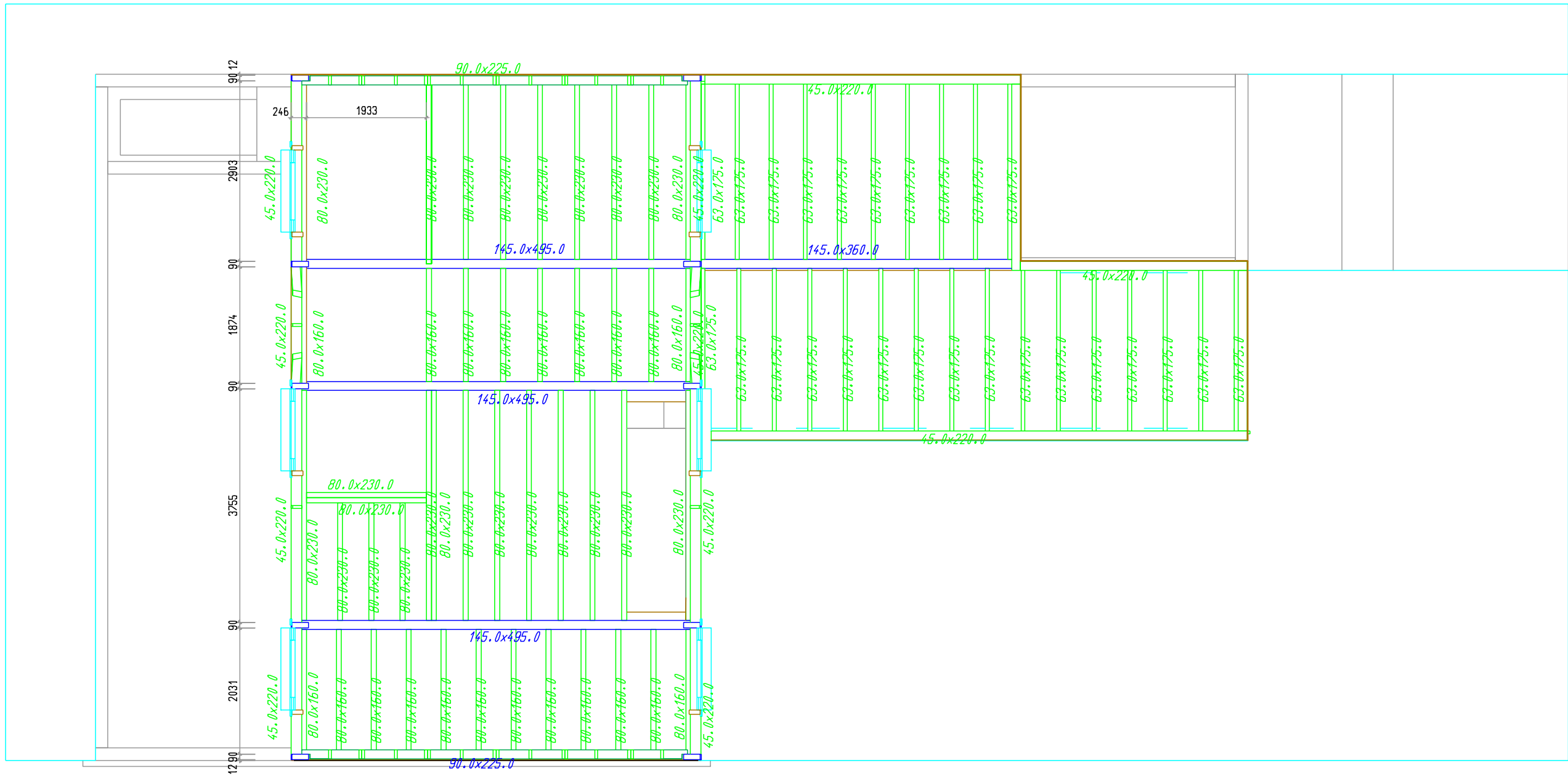

Maison locale d'activité

Saint Maur des Fossés

Echelle :

Date: 18/06/15

PLANCHER R+2

PLAN N°: - FEUILLE - Indice

2 - 14 -

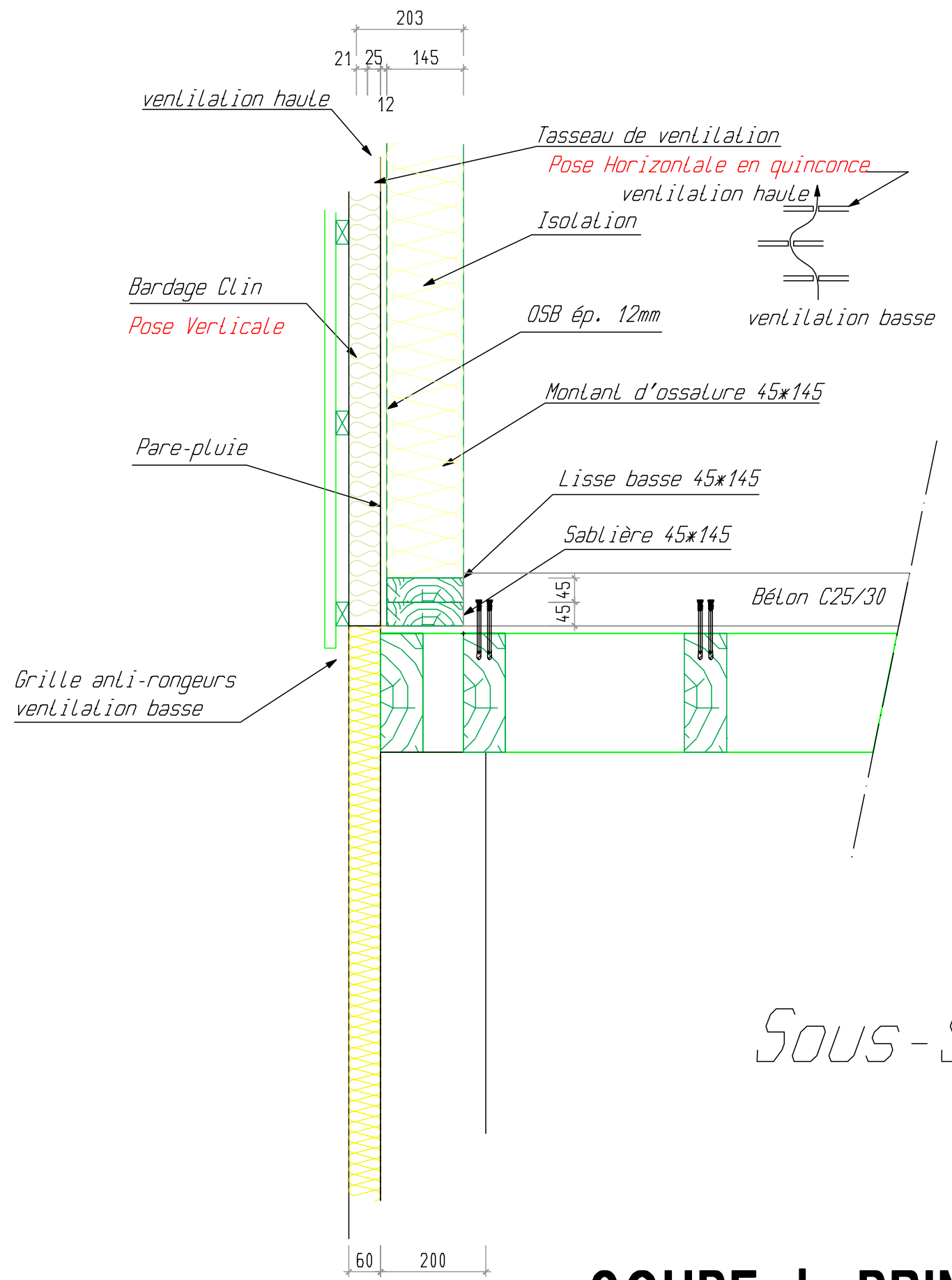
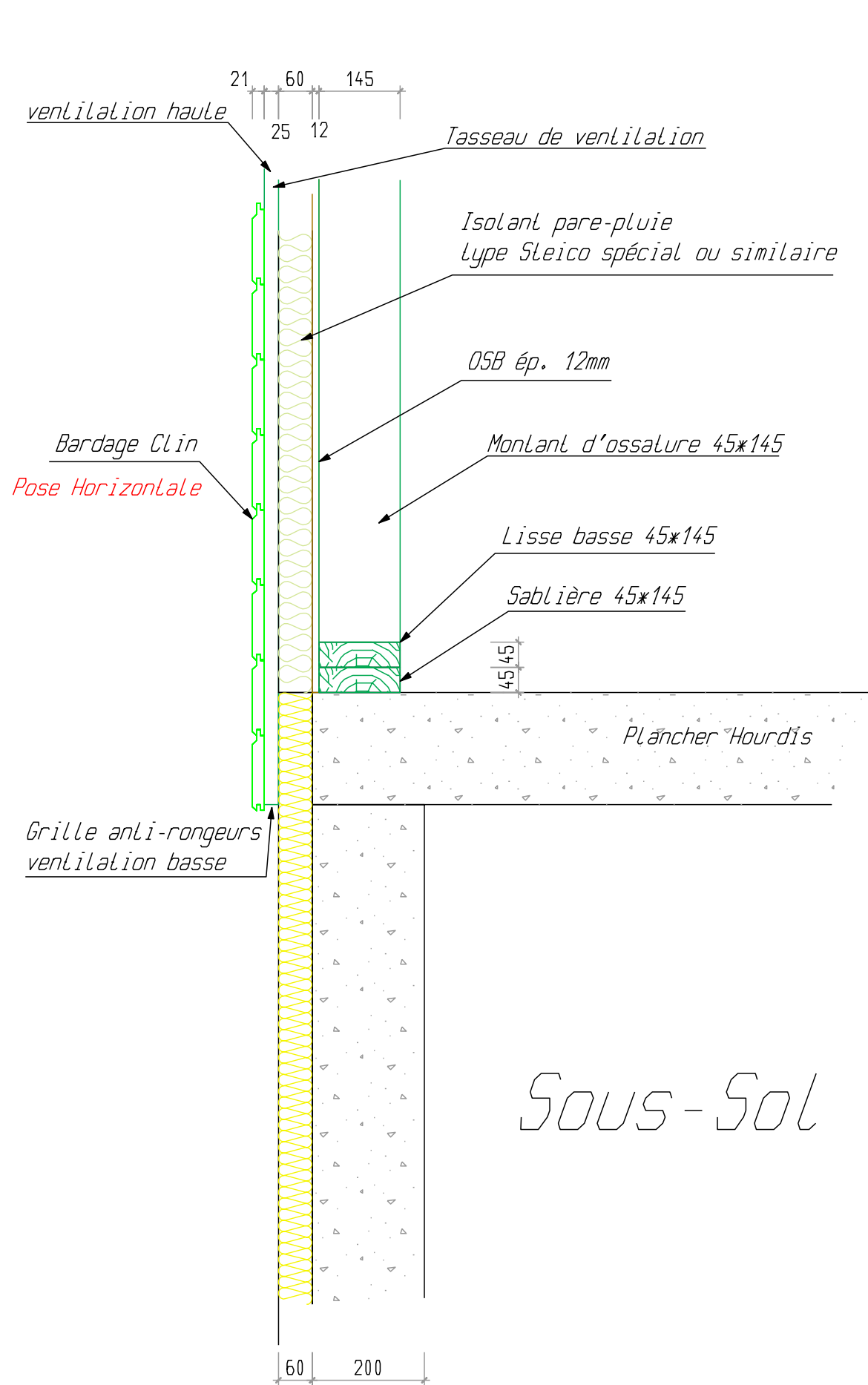

COUPE de PRINCIPE

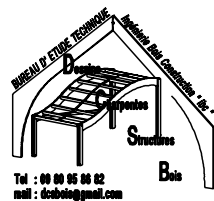

Maison locale d'activité

Saint Maur des Fossés

Echelle :

Date: 18/06/15

PLAN N°: - FEUILLE - Indice

2 - 15 -